



SAMSUNG

SPLIT-TYPE AIR CONDITIONER

Basic : AQ(S)18UBAXZ

Model: AQ(S)24UBAXX

Model Code : AQ18TSANSER AS18TSEANXCH AQ24TSANSER AS24TSEANXCH AQ18TSBNSER AQ18TSAN AQ18TSBN AQ24TSBNSER AQ24TSAN AQ24TSBN AQ24TUBANXAX AQ18TUBANXAX AS24TUBANXAX AS18TUBANXAX AS18TUBANXVN AS24TUBANXVN AS24TUBANXAP AS18TUBANXAP AQ24TSEANXCH AQ18TSEANXCH AQ18TSAXSER AS18TSEAXXCH AQ24TSAXSER AS24TSEAXXCH AQ18TSBXSER AQ18TSAX AQ18TSBX AQ24TSBXSER AQ24TSAX AQ24TSBX AQ24TUBAXXAX AQ18TUBAXXAX AQ24TUBAXXAX AS18TUBAXXAX AS18TUBAXXVN AS24TUBAXXVN AS24TUBAXXAP AS18TUBAXXAP AQ24TSEAXXCH AQ18TSEAXXCH

SERVICE *Manual*



AIR CONDITIONER



AS18TSEANXCH/AQ18TSANSER
AS24TSEANXCH/AQ24TSANSER
AQ18TSBNSER/AQ24TSBNSER
AQ18TSAN/AQ18TSBN/AQ24TSAN
AQ24TSBN/AQ24TUBANXAX
AQ18TUBANXAX/AS24TUBANXAX
AS18TUBANXAX/AS18TUBANXVN
AS24TUBANXVN/AS24TUBANXAP
AS18TUBANXAP/AQ24TSEANXCH
AQ18TSEAXXCH



AS18TSEAXXCH



AQ18TSAXSER/AS24TSEAXXCH
AQ24TSAXSER/AQ18TSBXSER
AQ18TSAX/AQ18TSBX
AQ18TUBAXXAX/AS18TUBAXXAX
AS24TUBAXXAX/AS18TUBAXXVN
AS24TUBAXXVN/AS18TUBAXXAP
AS24TUBAXXAP/AQ18TSEANXCH



AQ24TSAX
AQ24TSBX
AQ24TSBXSER
AQ24TUBAXXAX
AQ24TSEAXXCH

- 
- Cool Summer Offer
 - Cost Efficient System
 - Look for Everywhere
 - good'sleep function



Contents

1. Precautions	1-1
1-1 Precautions for the Service	1-1
1-2 Precautions for the Static Electricity and PL	1-1
1-3 Precautions for the Safety	1-2
2. Product Specifications	2-1
2-1 The Feature of Product	2-1
2-1-1 The Feature of Product	2-1
2-1-2 Modified items compared with Basic model	2-2
2-2 The Comparative Specifications of Product	2-3
2-3 Accessory and Option Specifications	2-6
2-3-1 Accessories	2-6
2-3-2 Filter	2-7
2-4 Details for Operation Property	2-8
3. Disassembly and Reassembly	3-1
3-1 Indoor Unit	3-2
3-2 Outdoor Unit	3-10
4. Troubleshooting	4-1
4-1 Setting Option Setup Method	4-1
4-2 Display Error and Check Method	4-3
4-2-1 Display Error mode	4-3
4-3 Fault Diagnosis by Symptom	4-4
4-3-1 Indoor Temperature Sensor Error <->When E 12 1 is displayed	4-4
4-3-2 Indoor Heat Exchanger Temperature Sensor Error<->When E 12 2 is displayed	4-5
4-3-3 Indoor Fan Motor Speed Detecting Error<->When E 15 4 is displayed	4-6
4-3-4 EEPROM Error or Option Error	4-7
4-3-5 No Power (completely dead)-Initial diagnosis (Not displayed)	4-8
4-3-6 When the Up/Down Louver Motor Does Not Operate. (Initial Diagnosis) (Not displayed)	4-9
4-3-7 When the remote control is not receiving	4-9
4-4 PCB Inspection Method	4-10
4-4-1 Pre-inspection Notices.....	4-10
4-4-2 Inspection Procedure.....	4-10
4-4-3 Indoor Detailed Inspection Procedure	4-10
4-5 Main Part Inspection Method	4-11



Contents

5. Exploded Views and Parts List	5-1
5-1 Indoor Unit	5-1
5-2 Outdoor Unit	5-6
6. PCB Diagram and Parts List	6-1
6-1. PCB Diagram	6-1
6-1-1. Ass'y Control in	6-1
6-1-2. Indoor MAIN PCB.....	6-5
6-1-3. Indoor Display PCB.....	6-6
6-2. Electrical Parts List	6-7
7. Wiring Diagram	7-2
8. Schematic Diagram	8-1
8-1.PCB Circuit Description	8-1
8-1-1.Indoor Unit.....	8-1
8-1-2.Display	8-2
9. Reference Sheet	9-1
9-1 Refrigerating Cycle Diagram	9-1
9-2 Index for Model Name	9-2
9-3 Pressure & Capacity mark	9-3
9-4 Low Refrigerant Pressure Distribution	9-4
9-5 Installation Diagram of Indoor Unit and Outdoor Unit	9-5



1. Precautions

1-1 Precautions for the Service

- **Use the standard parts when replacing the electric parts.**
 - Confirm the model name, rated voltage, rated current of the electric parts.
- **Repair the disconnection of HARNESS securely when repairing the break down.**
 - If there is any connection error, it causes an abnormal noise and incorrect operation.
- **In case that you assemble or disassemble the products with laying it on the side, do work on the work cloth.**
 - If not, the exterior of products can be scratched.
- **Remove dust and foreign materials from harness, connection part, and inspection part thoroughly when repairing the break down.**
 - It protects the danger of fire such as tracking and short.
- **Tighten tightly the service valve of outdoor unit and the cap of charging valve with a monkey spanner.**
- **Check the assembly status of parts after repairing the break down.**
 - It should be same as the status before repairing.

1-2 Precautions for the Static Electricity and PL

- **As the PCB power terminal has a weakness for the static electricity, pay attention to it during the repair and measurement.**
 - Work with insulation gloves during the repair and measurement of PCB.
- **Check the distance between the product and the other electronic appliances such as TV, Video, and audio. It should be over 2m.**
 - If not, it causes a bad picture quality or a noise.
- **Repairing the products by consumer should be strictly prohibited.**
 - There is a danger of electric shock or fire due to incorrect disassembly.





1-3 Precautions for the Safety

- Do not pull any electric wires and do not touch an auxiliary power switch with a wet hand.
- There is a danger of electric shock or fire.



- In case any wire or power plug has been damaged, replace it to eliminate any possible danger.
- Do not bend the power cord by force and do not put any heavy object on the power cord.
- There is a danger of electric shock or fire.



- Do not use multi socket.
- There is a danger of electric shock or fire.

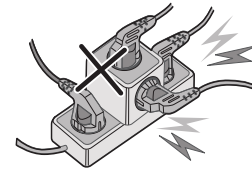

- Ground the product if necessary.
- Be sure to ground the product if there is any danger of electric leakage due to water or moisture.
- Be sure to turn off the auxiliary power switch or pull out the power plug during replacement or repair of electric parts.
- There is a danger of electric shock.
- In case the product will not be in use for a long time, the battery of remote control should be kept separately.
- Leakage of inside fluid can cause break down of remote control.





2. Product Specifications

2-1 The Feature of Product

2-1-1 The Feature of Product

Cool Summer Offer

On those hot sweltering summer days and long restless nights, there is no better escape from the heat than the cool comforts of home. Your new air conditioner brings an end to exhausting hot summer days and lets you rest. Beat the heat with your own air conditioner this summer.

Cost Efficient System

Your new air conditioner not only provides maximum cooling power in the summer, but also can be an efficient heating method in the winter with the advanced "Heat pump" system. "Heat pump" system is 3 times more efficient compare to the other electrical heating appliance, so you can further reduce its running cost. Now, meet year-round needs with one air conditioner.

Look for Everywhere









The elegant and harmonious design gives priority to the esthetics of your space and complements any of your existing interior décor. With its soft color and rounded-edge shape, the new air conditioner adds class to any room. Enjoy what your air conditioner offers both functionally and esthetically.

good'sleep function







good'sleep function allows you to set a comfortable sleep temperature while saving energy and having sound sleep.







2-1-2 Modified items compared with Basic model

Modified part	New contents and characteristic	Basical model	New model
		AQ(S)18UBAXAZ AQ(S)24UBAXAX	AS18TSEAXCH/AQ18TSASER/AS24TSEAXCH/AQ24TSASER/AQ18TSB SER/AQ18TSA/AQ18TSB/AQ24TSA/AQ24TSB/AQ24TSBSER AQ24TSEAXCH/AQ18TSEAXCH/AQ24TUBAXAX /AQ18TUBAXAX AS24TUBAXAX/AS18TUBAXAX /AS18TUBAXVN/ AS24TUBAXVN AS24TUBAXAP/AS18TUBAXAP
indoor	indoor design changed		
	Front Display changed		
outdoor	chassis changed	 AQ(S)18UBAXAZ AQ(S)24UBAXAX	 AS18TSEAXXCH AS18TUBAXXAX AS18TUBAXXVN AS18TUBAXXAP  AQ18TSAXSER/AS24TSEAXXCH AQ24TSAXSER/AQ18TSBXSER AQ18TSAX/AQ18TSBX AQ18TSEAXXCH/AS24TUBAXXAX AS24TUBAXXVN/AS24TUBAXXAP  AQ24TSAX AQ24TSBX AQ24TSBXSER AQ24TUBAXXAX AQ24TSEAXXCH

2-2 The Comparative Specifications of Product

ITEM	MODEL	Development Model				
		AS18TSEAXCH/AS18TUBAXX AS18TUBAXVN/AS18TUBAXAP	AQ18TSASER/AQ18TUBAXX AQ18TSEAXCH	AS24TSEAXCH/AS24TUBAXX AS24TUBAXVN/AS24TUBAXAP		
type		WALL MOUNTED	WALL MOUNTED	WALL MOUNTED		
Design	Indoor Unit					
	Outdoor Unit					
performance	Cooling/Heating(ISO)	KW	-	-	-	
		BTU/h	1800	18000/19500	24000	
	Cooling/Heating(SASO)	kcal	-	-	-	
	Dehumidifying	l/h	1.8	1.8	2.4	
	Noise	Indoor/outdoor	dB(H/L)	45/58	45/58	48/61
	EER	Cooling/Heating(ISO)	Btu/w-h	9.47	9.47/10.26	9.84
		Cooling/Heating(SASO)	Btu/w-h	-	-	-
Power		ph/V/Hz	1/220V/50Hz	1/230V/50Hz	1/220V/ 50Hz	
power	Power consumption	Cooling/Heating(ISO)	W	1900	1900/1900	2500
		Cooling/Heating(SASO)	Btu/w-h	-	-	-
	Operating current	Cooling/Heating(ISO)	A	9.0	9.0/9.0	12
		Cooling/Heating(SASO)	A	-	-	-
	Power factor	Cooling/Heating	%	98	98/98	98
	Starting current		A	21	21	21
	Power cord	Length	m	6	6	6
		Number of core wire	-	3	5	3
		Capacity	A	15	15	15
	size	Outer Dimension	Indoor	W*H*D(mm)	890*285*190	890*285*190
Outdoor				720*265*548	790*285*548	790*548*285
weight(net)		Indoor	kg	9.2	9.2	12.7
		Outdoor		32	39	51
Refrigerant pipe		liquid	D*L(mm)	6.35*4000	6.35*5000	15.88*4000
		gas		12.7*4000	12.7*5000	6.35*4000
Drain Hose		D*L(mm)	18*2000	18*2000	18*2000	
Heat exchanger	Indoor		Φ7.0,2R*14S*670/640	Φ7.0,2R*14S*670/640	Φ7.0,2R*14S*670/640	
	Outdoor		PFC	52,1R*20(21)S*846	PFC	
Refrigerant		g	R22 700	R22 1060	R22 870	
Freezer oil capacity		cc	500	500	750	
Refrigerant Control unit			Capillary tube	Capillary tube	Capillary tube	
Compressor			UR8B180DTAEHSS	UR8B200DUBEHSS	UR5A250JUAEMSS	
Protection device(OLP)			Internal	Internal	Internal	
Air purifying system			-	-	Catechin Filter Deodorizing Filter	
Cooling Test Condition			INDOOR UNIT: DB27°C/WB19°C , OUTDOOR UNIT: DB35°C/WB24°C			
Cooling operating condition			INDOOR UNIT: 16°C to 32°C , OUTDOOR UNIT: 15°C to 43°C			
Heating operating condition			-			



ITEM		MODEL		Development Model		Comparative Model	
				AQ24TSASER/ AQ18TSBNSER AQ18TSAN/AQ18TSBN	AQ24TSAN/AQ24TSEAXCH AQ24TUBAXAX/AQ24TSBN AQ24TSBNSER		
type				WALL MOUNTED	WALL MOUNTED		
Design	Indoor Unit						
	Outdoor Unit						
performance	Cooling/Heating(ISO)	KW		-	-		
		BTU/h		23200/24500	23300/24500		
	Cooling/Heating(SASO)	kcal		-	-		
	Dehumidifying	l/h		2.4	2.4		
	Noise	Indoor/outdoor	dB(H/L)		48/61		
	EER	Cooling/Heating(ISO)	Btu/w·h		9.28/9.25	9.52	
		Cooling/Heating(SASO)	Btu/w·h		9.79/10.25	9.79/10.25	
Power		ph/V/HZ		1/230V/50Hz	1/220V/60Hz		
power	Power consumption	Cooling/Heating(ISO)	W	2500/2650	2380/2390		
		Cooling/Heating(SASO)	Btu/w·h	-	-		
	Operating current	Cooling/Heating(ISO)	A	12/12.5	11.5/11.5		
		Cooling/Heating(SASO)	A	-	-		
	Power factor	Cooling/Heating	%	98/98	98/98		
	Starting current		A	21	21		
		Power cord	Length	m	6	6	
			Number of core wire	-	5	5	
	Capacity		A	15	15		
size	Outer Dimension	Indoor	W×H×D(mm)	1065×298×226	1065×298×226		
				790×548×285	880×310×638		
	weight(net)	Indoor	kg	13	13		
		Outdoor	kg	51	51		
	Refrigerant pipe	liquid	D×L(mm)	15.88×5000	15.88×5000		
		gas	D×L(mm)	6.35×5000	6.35×5000		
Drain Hose		D×L(mm)	18×2000	18×2000			
Heat exchanger	Indoor		Φ7.0.2R×14(16)S×850/830	Φ7.0.2R×15(16)S×850/830			
	Outdoor		Φ9.52.1.5R*20S*525/835	Φ7.0.2R*28S*915			
Refrigerant		g	R22 1400	R22 1600			
Freezer oil capacity		cc	750	750			
Refrigerant Control unit			Capillary tube	Capillary tube			
Compressor			UR5A250JUAEMSS	G5A240JUAEM-SS			
Protection device(OLP)			Internal	Internal			
Air purifying system			-	-			
Cooling Test Condition	INDOOR UNIT: DB27°C/WB19°C , OUTDOOR UNIT: DB35°C/WB24°C						
Cooling operating condition	INDOOR UNIT: 16°C to 32°C , OUTDOOR UNIT: 15°C to 43°C						
Heating operating condition	-						











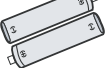

MEMO



2-3 Accessory and Option Specifications

2-3-1 Accessories

Item	Descriptions	Code-No.	Q'TY	Remark
	Plate-Hanger	DB97-02851C(AQ18**, AS18**) DB90-02738A(AQ24**, AS24**)	1	Indoor Unit
	Remote Control	DB93-11115K	1	
	Batteries for Remote Control	DB47-90024A	2	
	User's Manual	DB98-32709A	1	
	Installation Manual	DB98-32709A	1	
	5-wire Assembly Cable (AQ**)	DB39-01273B(AQ18**) DB39-01273A(AQ24**)	1	Outdoor Unit
	3-wire Assembly Cable (AS**)	DB39-01274B(AS18**) DB39-01274A(AS24**)	1	
	Rubber Leg	DB73-20134A	4	
	Assembly pipe, ø12.7mm, 7.5M	DB96-06533E (**18**)	1	Accessory Box
	Assembly pipe, ø15.88mm, 7.5M	DB96-06533G (**24**)	1	
	Assembly pipe, ø 6.35 mm, 7.5M	DB96-06533G (**18/24**)	1	

wash in water



Accessories(cont.)

Item	Descriptions	Code-No.	Q'TY	Remark
	Vinyl Tape,Width 80mm	DB72-00459A	1	
	Drain Plug	DB67-20011A(AQ** only)	1	
	Rubber Leg	DB73-20134A DB73-00182A(AS12*AA**/AS18**)	4	
	Cement Nail	-	6	
	M4xL25 Tapping Screws	6002-000540	6	
	Drain Hose,Length 2m	DB67-00461A	1	
	Putty 100g	DB98-10568A	1	

2-3-2 Filter

image	part name	Code no	Remark
	Pre-Filter	**18** : DB63-02759A (Left), DB63-02759A (Right) **24** : DB63-02757A (Left), DB63-02757A (Right)	wash in water



2-4 Details for Operation Property

1 AUTO MODE : In this mode, operation mode (COOL,HEAT) is selected automatically by the room temperature of initial operation.
(Set Temp. : 24°C)

2 COOL MODE : The unit operates according to the difference between the setting and room temperature.(16°C ~ 30°C)

3 HEAT MODE : The unit operates according to the difference between the setting and room temperature.(16°C ~ 30°C)
*Prevention against cold wind : In order to prevent the cool air from flowing out at the heat mode, the indoor fan does not operate or operates very slowly in the following cases. At this time, the indoor heat exchanger will be preheating.
– For 3~5 minutes after the initial operation
– For deicing operation
– The operation of an indoor fan in accordance with the temperature of an indoor heat exchanger.

The temperature of indoor heat exchanger	indoor fan speed
below 28°C	off
28°C~below 34°C	LL speed
34°C~below 40°C	L speed
above 40°C	Setting speed

*High temperature release function: It is a function to detect an outdoor overload by the sensor of an indoor exchanger and to turn the outdoor fan or the compressor ON/OFF for safety.

*Deice : Deicing operation is controlled by indoor unit's heat exchanger temperature and accumulating time of compressor's operation. Deice ends by sensing of the processing time by deice condition.

4 DRY MODE : Has 3 states, each determined by room temperature.
The unit operates in DRY mode.
*Compressor ON/OFF time is controlled compulsorily (can not set up the fan speed, always breeze)
*Protective function : Low temperature release. (Prevention against freeze)

5 TURBO MODE : This mode is available in AUTO, COOL,HEAT,DRY,FAN MODE.
When this button is pressed at first, the air conditioner is operated "powerful" state for 30 minutes regardless of the set temperature, room temperature.
When this button is pressed again, or when the operating time is 30 minutes, turbo operation mode is canceled and returned to the previous mode.
*But, if you press the TURBO button in DRY or FAN mode that is changed with AUTO mode automatically.

6 GOOD'SLEEP MODE : Default good'sleep time is set to 8 hours. But the good'sleep time can be set up to 12 hours, increasing in 30 minute unit up to first 3 hours and in hourly unit after first 3 hours.
*Temperature/Fan speed/Air swing can be adjusted after setting good'sleep in HEAT MODE.
*Temperature can be adjusted and the air conditioner automatically adjusts Fan speed/Air swing after setting good'sleep in COOL MODE.

7 FAN SPEED : Manual (3step),Auto (4 step)
Fan speed automatically varies depending on both the difference between setting and the room temperature.

8 COMPULSORY OPERATION : For operating the air conditioner without the remote control.
*The air conditioner starts up in the most suitable mode for the room temperature.

Option	Mode
Heat pump option selected	Auto mode
Cooling only option selected	Cooling mode

9 EVAP. CLEAN MODE : The unit operates according to the below.
*When the air conditioner is turned off.
The Evaporator clean indicator on the indoor unit display appears and the Evaporator cleaning function runs.
*When the air conditioner is turned on.
The Evaporator clean indicator on the indoor unit display appears and the Evaporator cleaning function runs after stopping the air conditioner operation.
*Evaporator cleaning time can vary, depending on the previously used mode.
1) Auto(COOL),COOL,DRY MODE : approximately 30 minutes.
2) Auto(HEAT),HEAT,FAN MODE : approximately 15 minutes.





MEMO







3. Disassembly and Reassembly

■ Necessary Tools







Item	Remark
SCREW DRIVER	
MONKEY SPANNER	



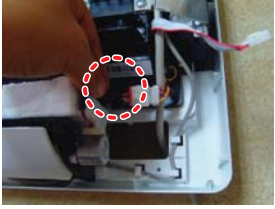



3-1 Indoor Unit

No	Parts	Procedure	Remark
1	PANEL-FRONT	<p>1) Stop the driving of air conditioner and shut off main power supply.</p> <p>2) Open the FRONT-GRILLE and pull out from the PANEL-FRONT.</p> <p>3) Detach COVER-TERMINAL from the PANEL-FRONT.(use + Screw Driver)</p> <p>4) Loosen connector wire(white) and detach the temperature sensor wire.</p> <p>5) To detach the FRONT-PANEL the main frame, unfasten 2 screw at the bottom.(use + Screw Driver)</p> <p>6) Take off the FRONT-PANEL, lifting up the bottom.</p>	    





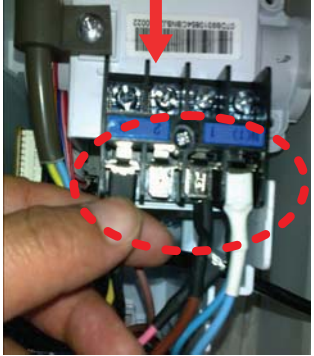

No	Parts	Procedure	Remark
2	TRAY DRAIN	1) Loosen stepping motor wire and detach the hook of main frame. 2) To detach TRAY-DRAIN from the main frame, pull the bottom of the TRAY-DRAIN towards you.	 
3	CONTROL IN	1) Unfasten the earth screw.(use + Screw Driver) 2) Detach the temperature sensor and Humidity sensor. 3) Detach COVER-CONTROL from the CASE-CONTROL. 4) Take off the CASE-CONTROL from the main frame.	   







No	Parts	Procedure	Remark
4	PBA	1) Unfasten the screw.	
		2) Cut the cable tie.	
		3) Loosen the terminal block wires. (Total 4EA: #N(T)-2EA, #2-TEA, #3-TEA) * Caution: The terminal is locking type. So, when you separate terminals, pull pressing the button.	   <p>Button</p>



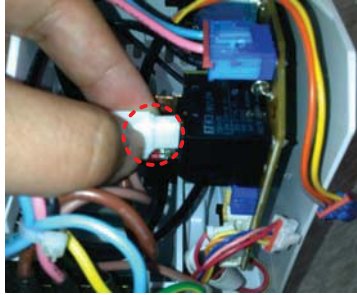

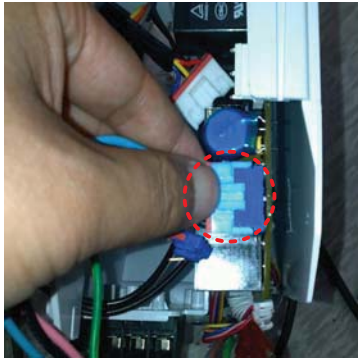

No	Parts	Procedure	Remark
4	PBA	4) Loosen the Motor Feedback connector(CN44). * Caution: When you separate the connector, pull pressing the locking button.	
		5) Loosen the Humidity sensor connector(CN42). → Option connector. * Caution: When you separate the connector, pull pressing the locking button.	
		6) Loosen the MPI connector(CN81). → Option connector. * Caution: When you separate the connector, pull pressing the locking button.	
		7) Loosen the Relay #4 blue-connector(RY71). * Caution: The terminal is locking type. So, when you separate terminals, pull pressing the button.  Button	



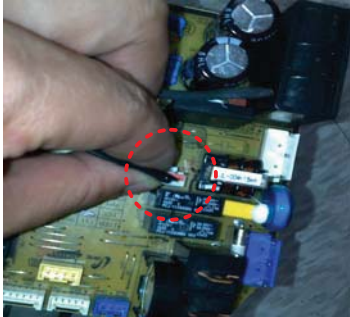

No	Parts	Procedure	Remark
4	PBA	8) Loosen the Relay #3 red-connector(RY71). * Caution: The terminal is locking type. So, when you separate terminals, pull pressing the button.	
		9) Loosen the Step motor connector. * Caution: When you separate the connector, pull pressing the locking button.	
		10) Loosen the Motor connector(CN71). * Caution: When you separate the connector, pull pressing the locking button.	
		11) Take off the main PBA from the ASSY Control in * Caution: When you take off the PBA, don't touch the components. Please hold the PBA both side.	

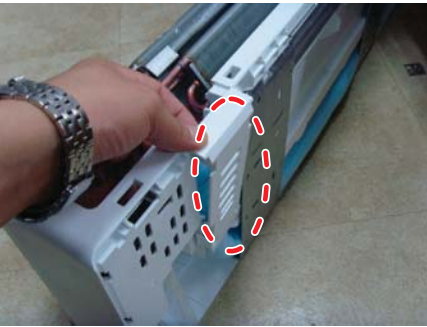

No	Parts	Procedure	Remark
4	PBA	12) Loosen the thermistor wire connector (CN43) * Caution: When you take off the PBA, don't touch the components. Please hold the PBA both side.	



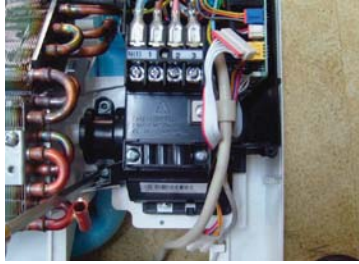

No	Parts	Procedure	Remark
5	EVAPORATOR	<p>1) Unfasten the screw at the right side. (use + Screw Driver)</p> <p>2) Unfasten the screw at the left side. (use + Screw Driver)</p> <p>3) Detach the HOLDER PIPE.</p> <p>4) Take off the EVAPORATOR from the main frame.</p>	   



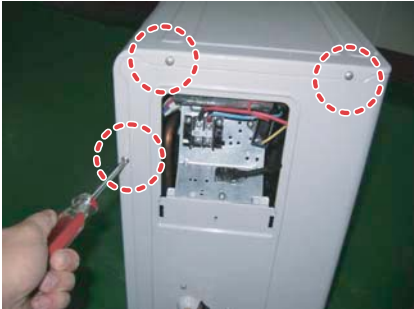

No	Parts	Procedure	Remark
6	FAN MOTOR & CROSS FAN	<p>1) Unfasten the screw in the HOLDER-EVAP on the left side of evaporator.(use + Screw Driver)</p> <p>2) unfasten the 3 points screws in the CASE-CONTROL, and then detach the CASE. (use + Screw Driver)</p> <p>3) unfasten the screw a little.(use + Screw Driver)</p> <p>4) Lift up the evaporator slightly and pull the CROSS-FAN to the left side.</p>	   



3-2 Outdoor Unit

No	Parts	Procedure	Remark
1	Common Work	<p>1) Loosen the fixing screw of the Cover Control.</p> <p>2) Loosen the fixing screws on right and left, back Cabinet-Side edge and a fixing screw on the Cabinet-Front lower to detach the Cabinet-Front.</p> <p>3) Loosen the fixing screws of the Ass'y-Control out.</p> <p>4) Loosen the fixing screws of the Cabinet-Side RH.</p> <p>5) Loosen the fixing screws of the Cabinet-Side LF.</p>	    

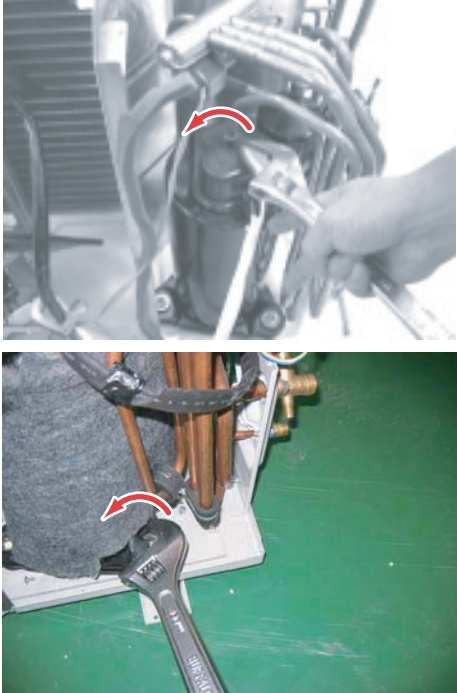
No	Parts	Procedure	Remark
2	Fan & Motor	1) Detach the Nut Flange.(Turn counterclockwise because the screw is right-handed) 2) Detach the Fan. 3) Loosen 4 fixing screws to detach the Motor.	
3	Heat Exchanger	1) Loosen 3 fixing screws of the Bar Steel. 2) Loosen 2 fixing screws on both sides. 3) Disassemble the pipe in both inlet and outlet with welding torch. 4) Detach the Heat Exchanger. ⚠ Before you disassemble the pipes and Condenser, be sure that there should be no refrigerant remained in the unit.	
4	Compressor	1) Loosen the Terminal Cover nut to open the Terminal Cover. 2) Disassemble the cloth sound felt. 3) Disassemble the pipe in both inlet and outlet of the Compressor with welding torch. 4) Loosen the 3 bolts at the bottom. 5) Detach the Compressor.	



MEMO





4. Troubleshooting

4-1 Setting Option Setup Method



























ex) Option No. : 30 00 07 C2 6C 83 10 00 00 00

Step 1 : Enter the Option Setup mode.































- 1st Take out the batteries of remote control.
- 2nd Press the temperature  button simultaneously and insert the battery again.
- 3rd Make sure the remote contr display shown as .



Step 2 : Enter the Option Setup mode and select your option according to the following procedure.

	Feature	Display
	1 The default value is  . Every time you push the  button, the display panel reads  Auto → Cool → Dry → Fan → Heat ,  Auto → Cool → Dry → Fan → Heat repeatedly.	
	2 Push the  button to set the display panel to 3 . Every time you push the  button, the display panel reads 0→1→2→3→.....→9→A→b→c→d→E→F repeatedly.	
	3 Push the  button to  . Every time you push the  button, the display panel reads 0→1→2→3→.....→9→A→b→c→d→E→F repeatedly.	
	4 Push the  button to  . Push the  button to set the display panel to 7 . Every time you push the  button, the display panel reads 0→1→2→3→.....→9→A→b→c→d→E→F repeatedly.	
	5 Push the  button to  . Push the  button to set the display panel to C . Every time you push the  button, the display panel reads 0→1→2→3→.....→9→A→b→c→d→E→F repeatedly.	
	6 Push the  button to set the display panel to 2 . Every time you push the  button, the display panel reads 0→1→2→3→.....→9→A→b→c→d→E→F repeatedly.	

4-1 Setting Option Setup Method(continue)

	Feature	Display
	<p>7 Push the  button to  . Push the  button to set the display panel to 6. Every time you push the  button, the display panel reads 0→1→2→3→.....→9→A→b→c→d→E→F repeatedly.</p>	
	<p>8 Push the  button to set the display panel to 8. Every time you push the  button, the display panel reads 0→1→2→3→.....→9→A→b→c→d→E→F repeatedly.</p>	
	<p>9 Push the  button to  . Push the  button to set the display panel to 8. Every time you push the  button, the display panel reads 0→1→2→3→.....→9→A→b→c→d→E→F repeatedly.</p>	
	<p>10 Push the  button to set the display panel to 3. Every time you push the  button, the display panel reads 0→1→2→3→.....→9→A→b→c→d→E→F repeatedly.</p>	
	<p>11 Push the  button to  . Push the  button to set the display panel to 1. Every time you push the  button, the display panel reads 0→1→2→3→.....→9→A→b→c→d→E→F repeatedly.</p>	
	<p>12 Push the  button to  .</p>	
	<p>13 Push the  button to  .</p>	
<p>14 Push the  button to  .</p>		

Step 3 : Upon completion of the selection, check you made right selections.

Press the Mode  Selection key to set the display part and check the display part.

➔ The display part shows like below when each time you press Mode button .



Step 4: Pressing the ON/OFF button (⏻)

When pressing the operation ON/OFF key with the direction of remote control for unit, the sound "Ding" or "Diriring" is heard and the OPERATION ICON(⏻) lamp of the display is flickering at the same time, then the input of option is completed. (If the diriring sound isn't heard, try again pressing the ON/OFF button.)

Step 5: Unit operation test-run

First, Remove the battery from the remote control.

Second, Re-insert the battery into the remote control.

Third, Press ON/OFF key with the direction of remote control for set.

• Error Mode

- 1st If all lamps of indoor unit are flickering, Plug out, plug in power plug again and press ON/OFF key to retry.
- 2nd If the unit is not working properly or all lamps are continuously flickering after setting the option code, see if the correct option code is set up for its model.

■ OPTION ITEMS

MODE \ REMOCON	SEG1	SEG2	SEG3	SEG4	SEG5	SEG6	SEG7	SEG8	SEG9	SEG10	SEG11	SEG12	SEG13	SEG14	SEG15	SEG16	SEG17	SEG18	SEG19	SEG20	SEG21	SEG22	SEG23	SEG24
AS24TSEAXCH AQ18TSEAXCH	0	1	7	8	2	4	1	7	C	2	6	C	2	8	1	1	0	0	3	0	0	0	0	0
AS18TSEAXCH	0	1	0	0	0	0	1	7	C	2	6	C	2	8	1	1	0	0	3	0	0	0	0	0
AQ18TSASER	0	2	0	0	0	0	1	7	C	3	4	0	2	8	1	1	0	0	3	0	0	0	0	0
AQ24TSASER	0	2	1	A	C	4	1	7	C	3	8	3	2	8	1	1	0	0	3	0	0	0	0	0
AQ24TUBAXAX AS24TUBAXAP AS24TUBAXAX AS24TUBAXVN	0	2	7	8	D	4	1	7	C	3	6	0	2	8	1	1	0	0	3	0	0	0	0	0
AQ18TSEAXCH AQ18TSAN AQ18TSBN AQ18TSBNSER	0	1	7	8	2	4	1	7	C	2	6	C	2	8	1	1	0	0	3	0	0	0	0	0
AQ24TSAN AQ24TSBN AQ24TSBNSER	0	2	4	9	0	4	1	7	C	2	6	E	2	8	1	1	0	0	3	0	0	0	0	0
AS18TUBAXAP AS18TUBAXAX AS18TUBAXVN	0	1	0	0	0	0	1	7	C	2	6	C	2	8	1	1	0	0	3	0	0	0	0	0
AQ18TUBAXAX	0	1	7	A	E	6	1	7	C	2	6	C	2	8	1	1	0	0	3	0	0	0	0	0
AQ24TSEAXCH	0	2	1	A	C	4	1	7	C	3	8	4	2	8	1	1	0	0	3	0	0	0	0	0

4-2 Display Error and Check Method

4-2-1 Display Error mode

ERROR MODE				CAUSE
AQ18/24E**	AQ18/24UR**			
7-SEG	OPER- ATION	TIMER	SMART SAVER	
E121	○	◎	○	INDOOR TEMPERATURE SENSOR ERROR
E122	◎	◎	○	INDOOR HEAT EXCHANGER TEMPERATURE SENSOR ERROR
E154	○	○	◎	INDOOR FAN MOTOR SPEED DETECTING ERROR
E162, LED BLINKING	◎	◎	◎	EEPROM ERROR(LED RANDOM BLINKING)
7-SEG, LED BLINKING	◎	◎	◎	OPTION ERROR(LED RANDOM BLINKING)
E142	NO USED			HUMIDITY SENSOR ERROR(IN TEST MODE)
● LED ON ○ LED OFF ◎ LED BLINKING				

* "E162" Error is displayed only in test mode. So, if you want to check, please push the power button of indoor unit.



4-3 Fault Diagnosis by Symptom

4-3-1 Indoor Temperature Sensor Error ↔ When E_{12} or OPERATION(○) and TIMER (◎) and SMART SAVER(○) is displayed

1. Checklist :
 - 1) Is the indoor units temperature sensor connected correctly?
2. Troubleshooting procedure

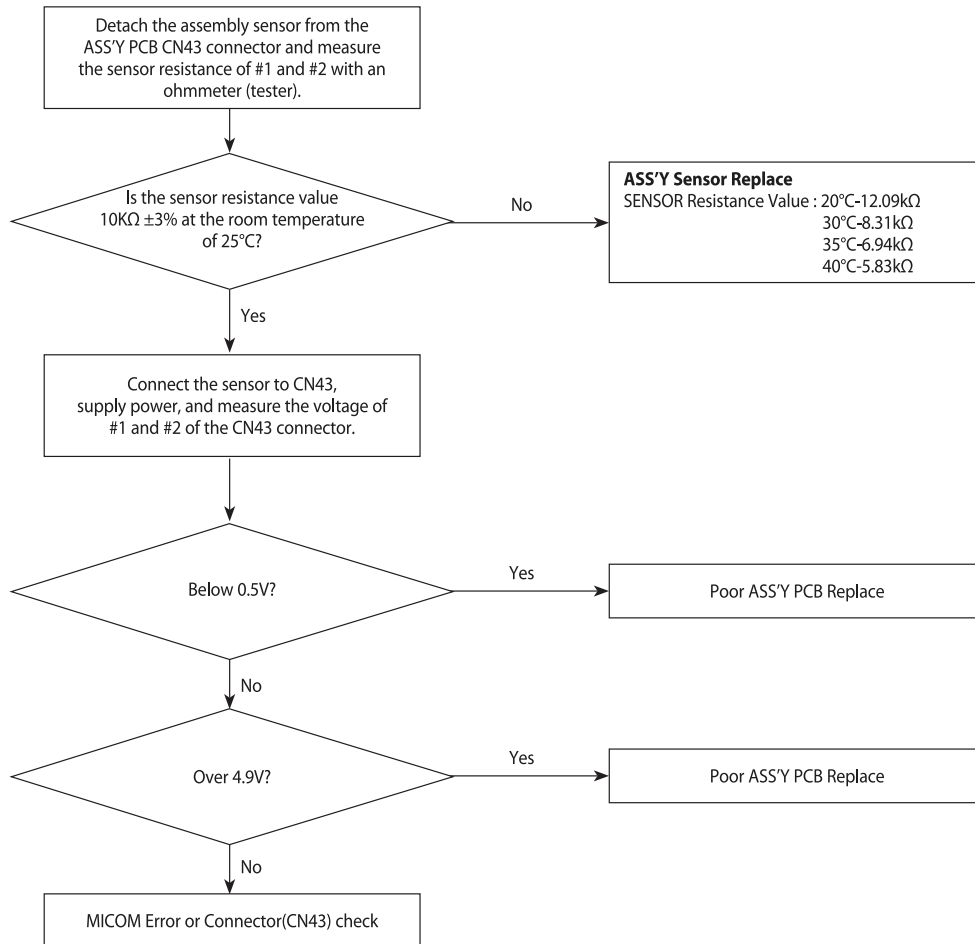



4-3-2 Indoor Heat Exchanger Temperature Sensor Error ↔ When $\xi 122$ or OPERATION(\odot) and TIMER(\odot) and SMARTSAVER(\circ) is displayed

1. Checklist :
 - 1) Is the indoor units temperature sensor connected correctly?
2. Troubleshooting procedure

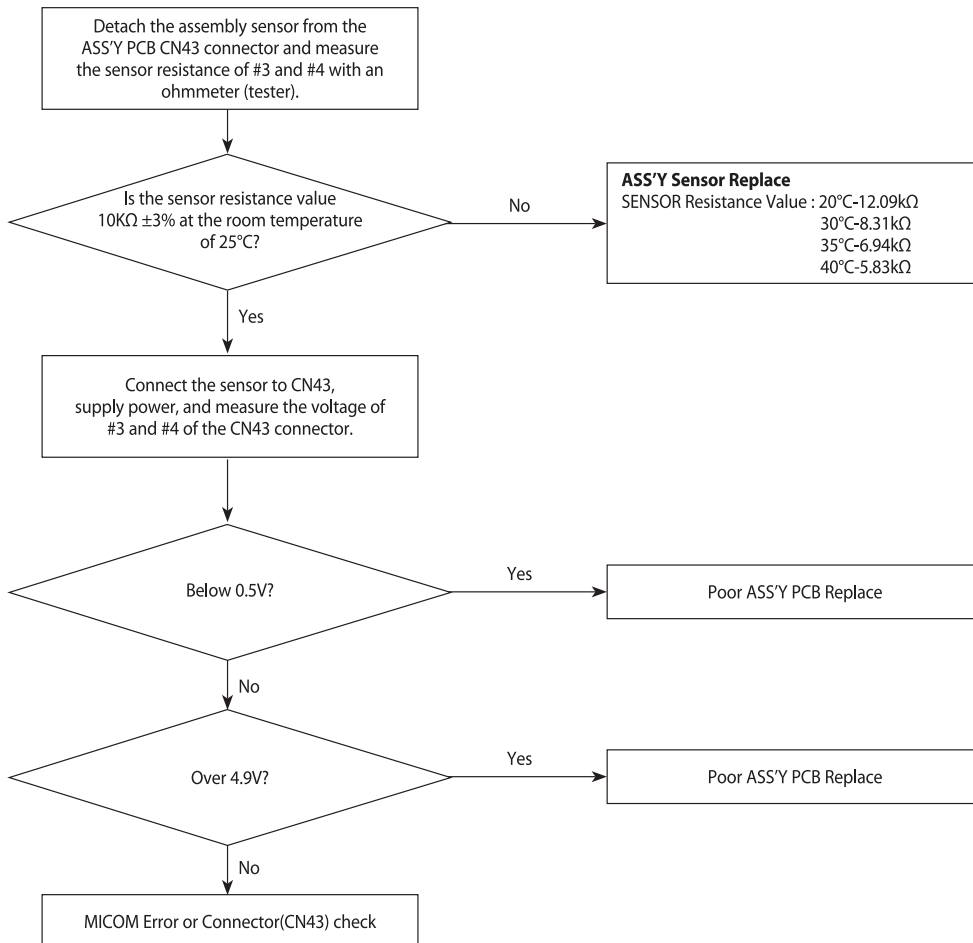



4-3-3 Indoor Fan Motor Speed Detecting Error ↔ When E 154 or OPERATION(○) and TIMER(○) and SMART SAVER(⊙) is displayed

1. Checklist :
 - 1) Is the indoor unit fan motor properly connected with the connector (CN72)?
 - 2) Is the AC voltage correct?
 - 3) Is HALL IC in indoor fan motor properly connected with the connector (CN44)?
 - 4) Is the running capacitor (CR71) properly connected with PCB board?
2. Troubleshooting procedure

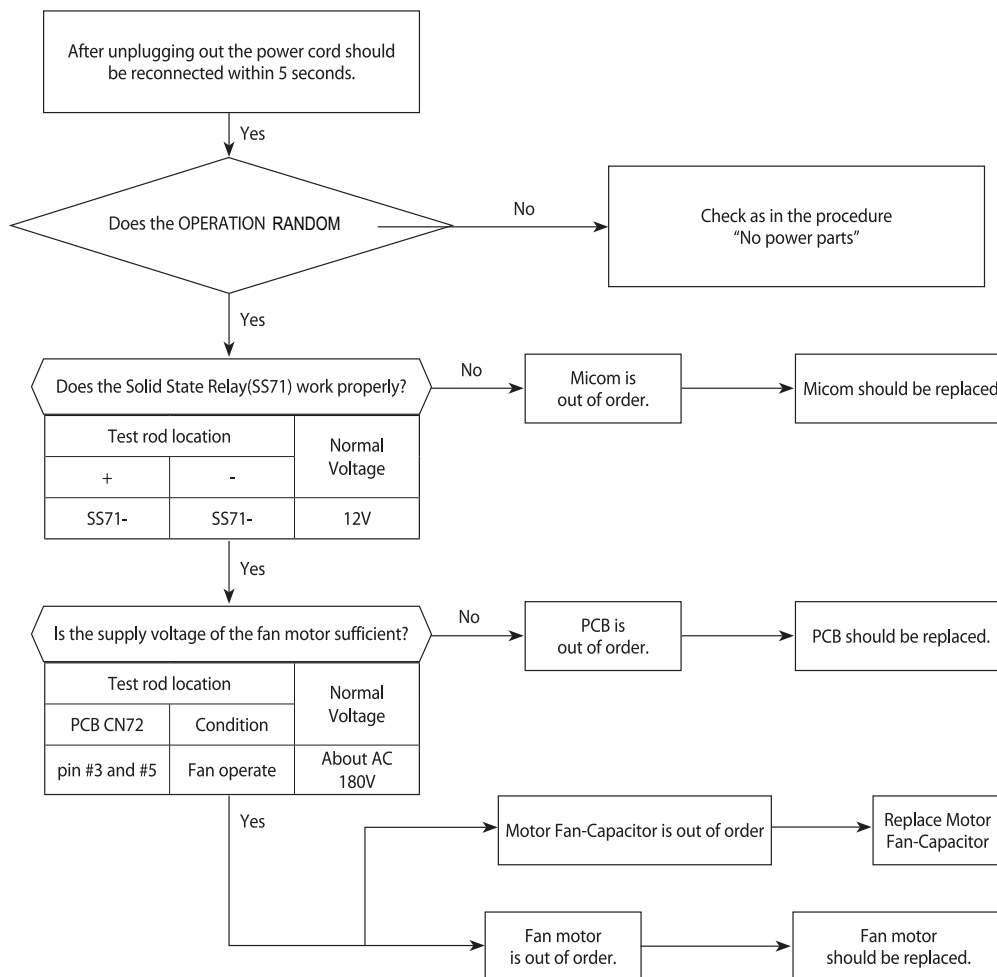

*CHECK CN11 (12V CONNECT)



4-3-4 EEPROM Error or Option Error

1. Checklist :

- 1) If all lamps of Indoor unit are blinking or E162 is displayed, plug out, plug in power plug again and press ON/OFF key to retry.
- 2) If the unit is not working properly or all lamps are continuously blinking or E162 is displayed after resetting the option code, see if the correct option code is set up for its model.
- 3) Nevertheless, if all lamps are blinking or E162 is displayed, exchange the main PBA.



4-3-5 No Power (completely dead)-Initial diagnosis (Not displayed)

1. Checklist :

- 1) Is input voltage normal?
- 2) Is AC power linked correctly?
- 3) Is input voltage of DC regulator IC KA7805 (IC02) normal? (11VDC-12.5VDC)
- 4) Is output voltage of DC regulator IC KA7805 (IC02) normal? (4.5VDC-5.5VDC)

2. Troubleshooting procedure

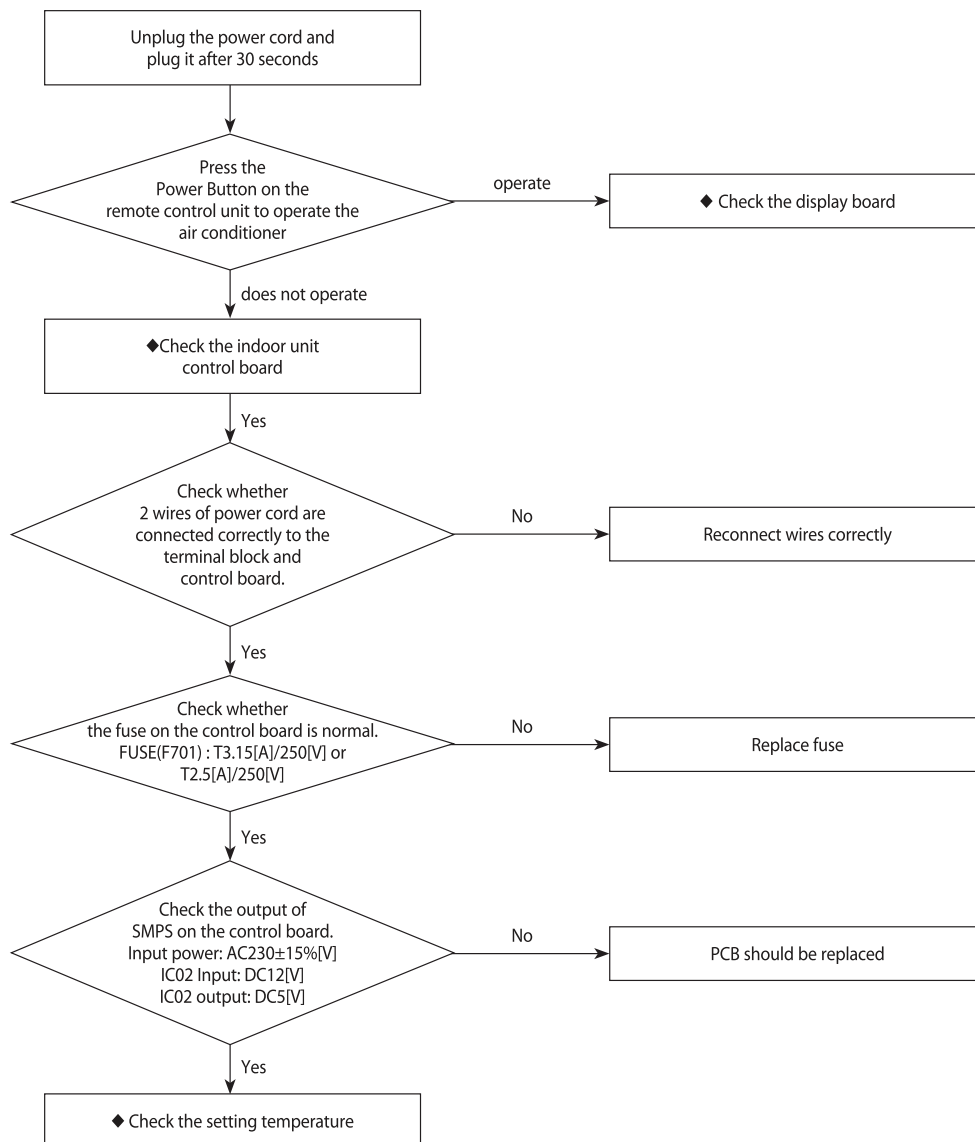

*CHECK CN11 (12V CONNECT)



4-3-6 When the Up/Down Louver Motor Does Not Operate. (Initial Diagnosis) (Not displayed)

1. Checklist :
 - 1) Is input voltage normal?
 - 2) Is the Up/Down louver motor properly connected with the connector (CN61)?
2. Troubleshooting procedure

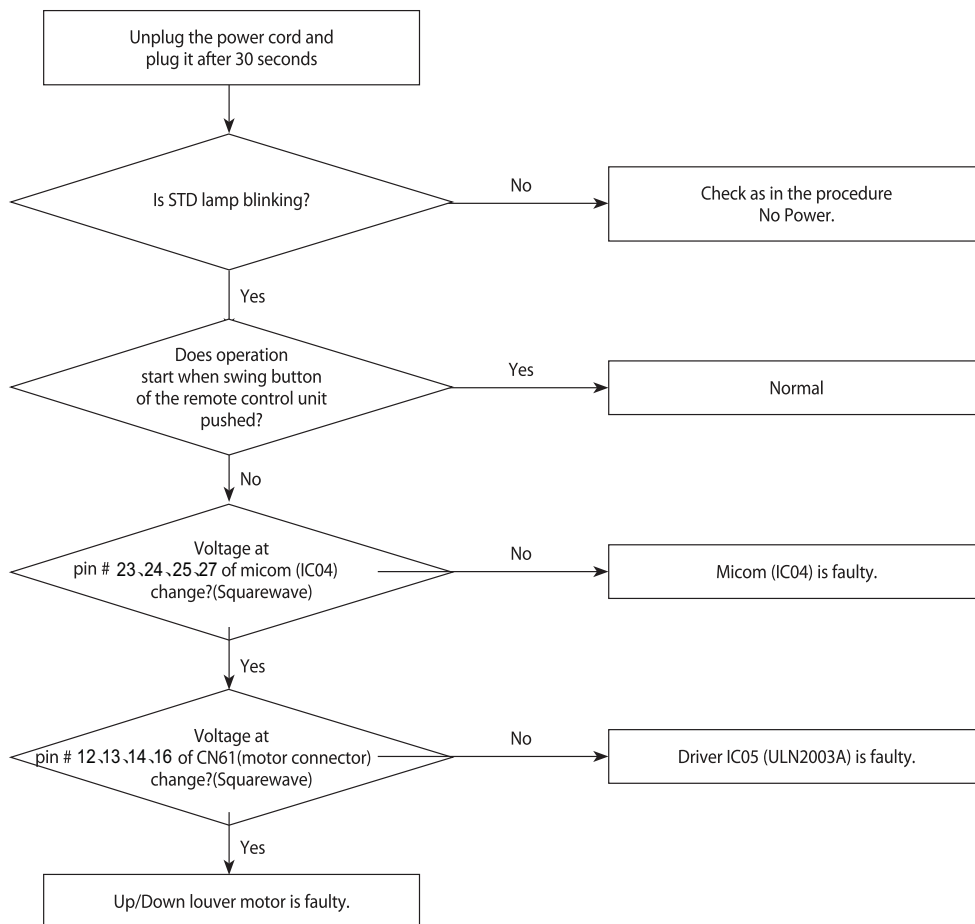

4-3-7 When the remote control is not receiving

1. Check if the connector was normally assembled.
2. Put the set in operation and check the voltage of pin # 7 and pin # 5 of the main PCB CN91 while operating the remote control. When the voltage descends below 3V, the assembly module PCB is normal and the main PCB is poor. Then replace the main PCB.
3. Replace the assembly display PCB because the module PCB is poor if the voltage between pin #5, # 7 of CN91 maintains 5V after the remote control starts operation.



4-4 PCB Inspection Method

4-4-1 Pre-inspection Notices

1. Check if you pulled out the AC power plug when you eliminate the PCB or front panel.
2. Don't hold the PCB side not impose excessive force on it to eliminate the PCB.
3. Don't pull the lead wire but hold the whole housing to connect or disconnect a connector to the PCB.

4-4-2 Inspection Procedure

1. Check connector connection and peeling of PCB or bronze coating pattern when you think the PCB is broken.
2. The PCB is composed of the 2 parts.
 - Indoor Main PCB Part : MICOM and surrounding circuit, relay, room fan motor driving circuit and control circuit, sensor driving circuit, power circuit of DC12V and DC5V, and buzzer driving circuit.
 - Display part : LED lamp, Switch, Remocon module

4-4-3 Indoor Detailed Inspection Procedure

No	Procedure	Inspection Method	Cause
1	Plug out and pull the PCB out of the electronic box. Check the PCB fuse.	1) Is the fuse disconnected?	<ul style="list-style-type: none"> • Over current • Indoor Fan Motor Short • AC Part Pattern Short of the MAIN PCB
2	Supply power. If the operating lamp twinkles at this time, the above 1)~3) have no relation.	Checking the power voltage.	
		1) Is the BD71 input voltage AC200V~AC240V?	• Power Cord is fault, Fuse open. Wrong Power Cable Wiring, AC Part is faulty.
		2) Is the voltage between both terminals of the C109 on the 2 nd side of the transformer DC12V $\pm 0.5V$?	• Switching Trans or Power Circuit is faulty
		3) Is the voltage between both terminals of OUT and GND of IC02(KA7805) DC5V $\pm 0.5V$?	• Power Circuit is faulty, Load Short
		4) Voltage over 310V	• SMPS protect
3	Press the ON/OFF button.	Checking the power voltage.	
		1) Is the voltage over AC180V being imposed on terminal #3 and #5 of the fan motor connector(CN72)?	• Fan Motor of the indoor is faulty
		2) Check the voltage of both terminals of terminal block 1 and N(1) after 3 minute operation.: AC220V	• Relay(RY71) Contact is faulty
4	Press the ON/OFF button. 1. FAN Speed [High] 2. Continuous Operation	1) Is the voltage over AC180V being imposed on terminal #3 and #5 of the fan motor connector(CN72)?	• Fan Motor of the indoor is faulty
		2) The fan motor of the indoor unit doesn't run.	• Fan Motor Connector(CN72) is faulty
		3) The power voltage between terminal #3 and #5 of the connector(CN72) is 0V.	<ul style="list-style-type: none"> • ASS'Y Main PCB is faulty • Connection is faulty



4-5 Main Part Inspection Method

Part	Breakdown Inspection Method													
Room Temperature Sensor	Measure resistance with a tester													
	Normal	At the normal temperature 37kΩ~ 8.3kΩ(-7°C~+30°C) .												
	Abnormal	∞, 0Ω . . . Open or Short												
Room Fan Motor	Measure the resistance between terminals of the connector (CN72) with a tester.													
	Normal	At the normal temperature (10°C ~ 30°C)												
		<table border="1"> <thead> <tr> <th></th> <th>Compare terminal</th> <th>Resistance</th> <th>Remark</th> </tr> </thead> <tbody> <tr> <td rowspan="2">FAN MOTOR</td> <td>Yellow, Blue</td> <td>385Ω±10%</td> <td>main</td> </tr> <tr> <td>Yellow, Red</td> <td>388Ω±10%</td> <td>sub</td> </tr> </tbody> </table>		Compare terminal	Resistance	Remark	FAN MOTOR	Yellow, Blue	385Ω±10%	main	Yellow, Red	388Ω±10%	sub	
			Compare terminal	Resistance	Remark									
FAN MOTOR	Yellow, Blue	385Ω±10%	main											
	Yellow, Red	388Ω±10%	sub											
Abnormal	∞, 0Ω . . . Open or Short													
Stepping Motor	Measure the resistance between the red wire and each terminal wire with a tester.													
	Normal	About 300Ω at the normal temperature (20°C ~ 30°C)												
		<table border="1"> <thead> <tr> <th></th> <th>Compare terminal</th> <th>Resistance</th> <th>Remark</th> </tr> </thead> <tbody> <tr> <td>STEP MOTOR</td> <td>Red-Pink,Yel,Blu,Org</td> <td>120±7%</td> <td>GRILLE</td> </tr> <tr> <td>STEP MOTOR</td> <td>Red-Pink,Yel,Blu,Org</td> <td>300±7%</td> <td>BLADE</td> </tr> </tbody> </table>		Compare terminal	Resistance	Remark	STEP MOTOR	Red-Pink,Yel,Blu,Org	120±7%	GRILLE	STEP MOTOR	Red-Pink,Yel,Blu,Org	300±7%	BLADE
			Compare terminal	Resistance	Remark									
STEP MOTOR	Red-Pink,Yel,Blu,Org	120±7%	GRILLE											
STEP MOTOR	Red-Pink,Yel,Blu,Org	300±7%	BLADE											
Abnormal	∞, 0Ω . . . Open or Short													



5. Exploded Views and Parts List

5-1 Indoor Unit

AQ18TSANSER
AS18TSEANXCH
 AQ18TSEAXNCH
 AQ18TUBAXNAX
 AS18TUBAXNAX
 AS18TUBAXNVN
 AS18TUBAXNAP

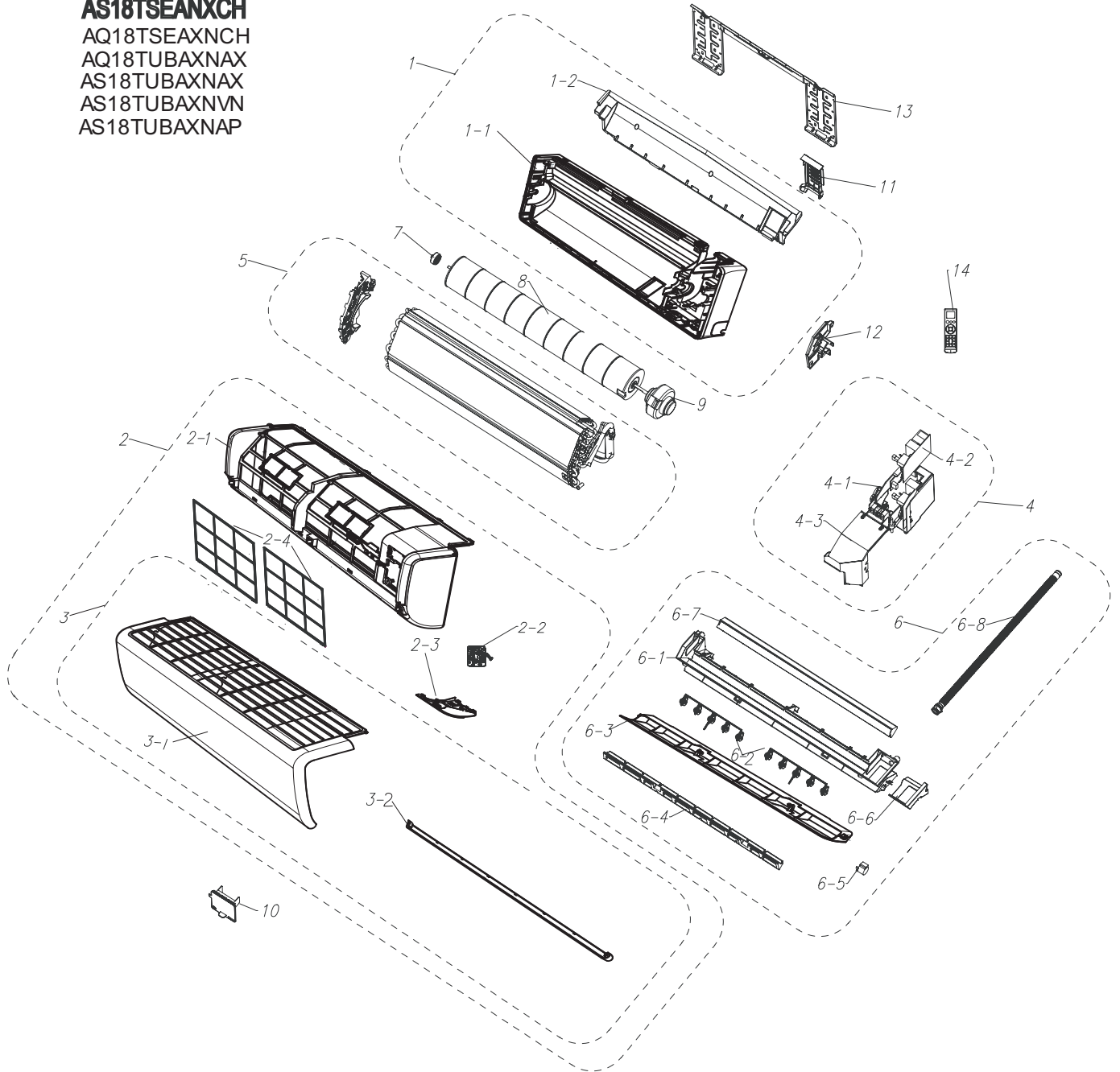

Exploded Views and Parts List

No	Code No.	Description	Specification	Q'TY				SA/SNA
				AQ18TSANSER	AS18TSEANXCH	AQ18TUBANXAX	AS18TUBANXVX AS18TUBANXAF	
1	DB94-01923B	ASSY BACK BODY	ASSY	1	1	1	1	SA
1-1	DB61-03663A	BODY BACK	HIPS	1	1	1	1	SA
1-2	DB62-05905A	INSULATION-BODY REAR	EPS	1	1	1	1	SA
2	DB92-02276A	ASSY PANEL FRONT	ASSY	1	1	1	1	SA
2-1	DB64-02547A	PANEL FRONT	HIPS	1	1	1	1	SA
2-2	DB93-10861A	ASSY PCB SUB-DISPLAY	ASSY	1	1	1	1	SA
2-3	DB90-06117A	ASSY COVER DISPLAY	ASSY	1	1	1	1	SA
2-4	DB63-02759A	FILTER-PRE	PP	2	2	2	2	SA
3	DB92-02277A	ASSY GRILLE	ASSY	1	1	1	1	SA
3-1	DB64-02557A	GRILLE-AIR INLET	HIPS	1	1	1	1	SA
3-2	DB64-02551A	DECO-GRILLE	HIPS	1	1	1	1	SA
4	DB93-10854C	ASSY CONTROL IN	ASSY	1	-	-	-	SA
	DB93-10854D			-	1	-	-	SA
	DB93-10854A			-	-	1	-	SA
	DB93-10854B			-	-	-	1	SA
4-1	DB90-06305B	ASSY CASE CONTROL-IN	ASSY	1	1	1	1	SA
4-2	DB93-10859A	ASSY PCB MAIN	ASSY	1	-	1	-	SA
	DB93-10859D			-	1	-	1	SA
4-3	DB90-04385A	ASSY COVER CONTROL IN	SGCC-M,T0.5	1	1	1	1	SA
5	DB96-11110A	ASSY EVAP TOTAL	ASSY	1	1	-	-	SA
	DB96-11110C			-	-	1	1	SA
6	DB94-02957A	ASSY TRAY DRAIN	ASSY	1	1	1	1	SA
6-1	DB63-02134A	TRAY DRAIN	ABS	1	1	1	1	SA
6-2	DB61-03672A	BLADE-V	PP	1	1	1	1	SA
6-3	DB66-01562A	BLADE-H	ABS	1	1	1	1	SA
6-4	DB62-05904A	INSULATION-TRAY FR	EPS	1	1	1	1	SA
6-5	DB31-00371A	MOTOR STEP	DC12V,600GF-CM	1	1	1	1	SA
6-6	DB69-00839A	CUSHION-TRAY RH	EPS	1	1	1	1	SA
6-7	DB63-02135A	TRAY-STABILIZER	HIPS	1	1	1	1	SA
6-8	DB94-00458D	ASSY HOSE DRAIN	ASSY	1	1	1	1	SA
7	DB94-00455B	ASSY-RUBBER BEARING	ASSY	1	1	1	1	SA
8	DB94-01874B	ASSY-CROSS FAN	ASSY(AS+GF20%)	1	1	1	1	SA
9	DB31-00532A	MOTOR FAN	60HZ	1	1	1	1	SA
10	DB97-11240C	ASSY COVER TERMINAL	ABS	1	1	1	1	SA
11	DB61-03666A	HOLDER-PIPE		1	1	1	1	SA
12	DB61-03651B	SUPPORT-EVAP RH	HIPS	1	1	1	1	SA
13	DB97-02851C	ASSY-PLATE HANGER	SGCC-M,T0.6	1	1	1	1	SA
14	DB93-11115K	ASSY REMOCON	ASSY	1	1	1	1	SA

Samsung Electronics



5-1 Indoor Unit

AQ24TSANSER/AQ24TSBNSER
AS24TSEANXCH/AQ18TSBNSER
AQ18TSAN/AQ18TSBN
AQ24TSANA/AQ24TSBN
 AQ24TSEANXCH/AQ24TUBANXAX
 AS24TUBANXAX/AS24TUBANXVN
 AS24TUBANXAP

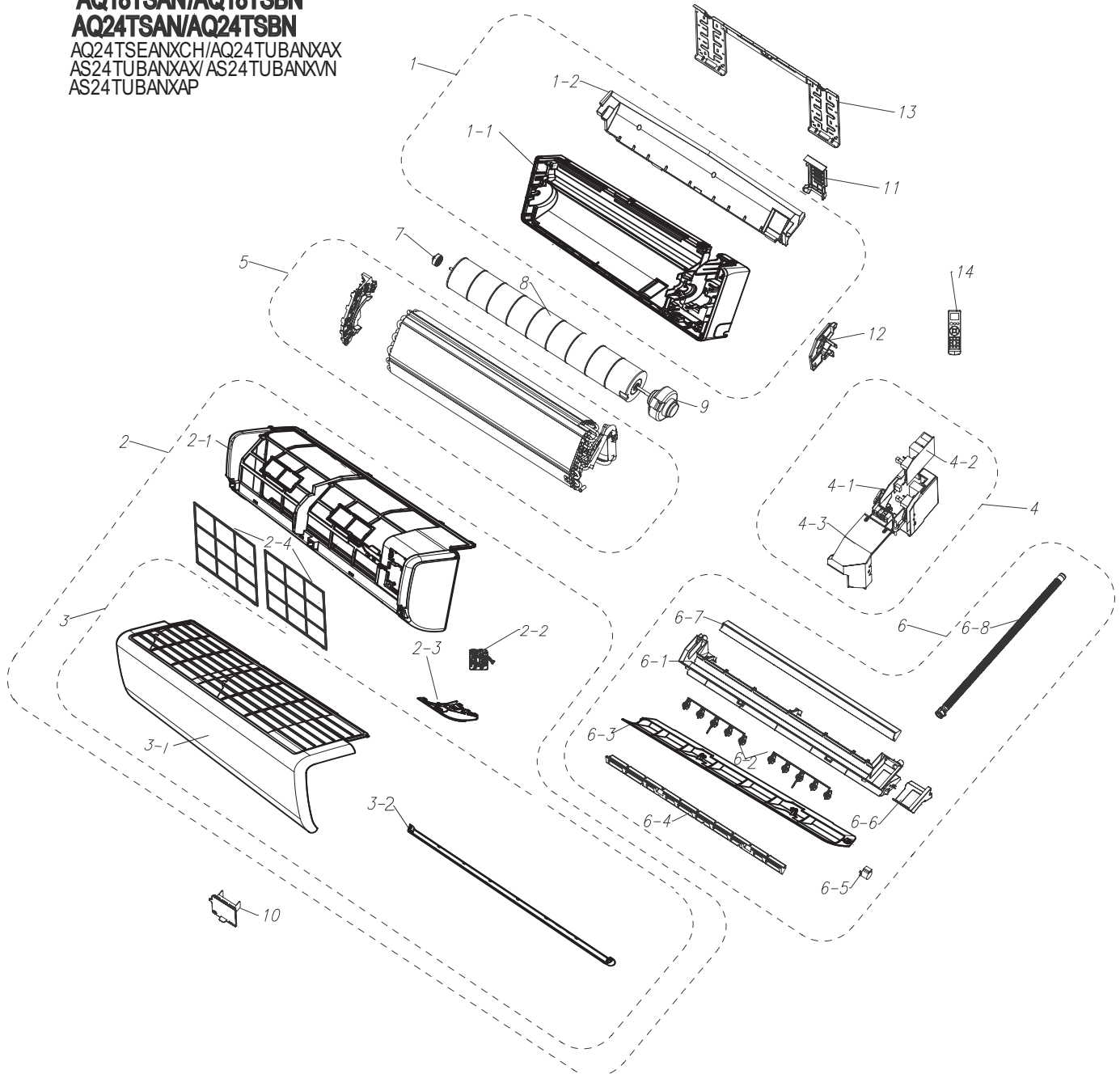



NO.	Code No.	Description	Specification	QTY							SA/SNA
				AQ24TASN SER	AS24TSEAN XCH	AQ18TSBNSER AQ18TSAN	AQ18TSBN	AQ24TSBNSER AQ24TSBN	AQ24TUBAN XAX	AS24TUBANXAX AS24TUBANXVM AS24TUBANXAP	
1	DB94-00615F	ASSY BACK BODY	ASSY	1	1	1	1	1	1	1	SA
1-1	DB61-04681A	BODY BACK	HIPS	1	1	1	1	1	1	1	SA
1-2	DB69-01039A	CUSHION-BACK BODY	EPS	1	1	1	1	1	1	1	SA
2	DB92-02274A	ASSY PANEL FRONT	ASSY	1	1	-	-	-	1	1	SA
	DB92-02274B			-	-	1	1	1	-	-	SA
2-1	DB64-02548A	PANEL FRONT	HIPS	1	1	1	1	1	1	1	SA
2-2	DB93-11027A	ASSY PCB SUB-HVPS	ASSY	1	1	1	1	1	1	1	SA
2-3	DB90-06122A	ASSY COVER DISPLAY	ASSY	1	1	1	1	1	1	1	SA
2-4	DB63-02757A	FILTER-PR	PP	2	2	2	2	2	2	2	SA
3	DB92-02275A	ASSY GRILLE	ASSY	1	1	-	-	-	1	1	SA
	DB92-02275B			-	-	1	1	1	-	-	SA
3-1	DB64-02563A	GRILLE-AIR INLET	HIPS	1	1	1	1	1	1	1	SA
3-2	DB64-02562A	DECORATION-GRILLE	HIPS	1	1	-	-	-	1	1	SA
	DB64-02562B			-	-	1	1	1	-	-	SA
4	DB93-10855A	ASSY CONTROL IN	ASSY	1	-	-	-	1	1	-	SA
	DB93-10855B			-	1	-	-	-	-	1	SA
	DB93-10855E			-	-	1	1	-	-	-	-
4-1	DB61-04576A	CASE CONTROL IN	ABS	1	1	1	1	1	1	1	SA
4-2	DB93-10860A	ASSY PCB MAIN	ASSY	1	-	1	1	1	1	-	SA
	DB93-10860B			-	1	-	-	-	-	1	SA
4-3	DB90-06284A	ASSY COVER CONTROL IN	SGCC-M,T0.5	1	1	1	1	1	1	1	SA
5	DB96-12677B	ASSY EVAP TOTAL	ASSY	1	1	-	-	-	-	-	SA
	DB96-12677A			-	-	1	-	-	-	-	SA
	DB96-11817A			-	-	-	1	-	-	-	SA
	DB96-11950A			-	-	-	-	1	-	-	SA
	DB96-12677E			-	-	-	-	-	1	-	SA
	DB96-12677D			-	-	-	-	-	-	1	SA
6	DB94-02953A	ASSY TRAY DRAIN	ASSY	1	1	1	1	1	1	1	SA
6-1	DB63-01071A	TRAY DRAIN	ABS	1	1	1	1	1	1	1	SA
6-2	DB61-03660A	BLADE-V	PP	1	1	1	1	1	1	1	SA
6-3	DB66-01563A	BLADE-H	ABS	1	1	1	1	1	1	1	SA
6-4	DB62-02942A	SEAL-TRAY LF	EPS	1	1	1	1	1	1	1	SA
6-5	DB31-00370A	MOTOR STEP	DC12V,600GF-CM	1	1	1	1	1	1	1	SA
6-6	DB62-02941A	SEAL-TRAY RH	EPS	1	1	1	1	1	1	1	SA
6-7	DB63-01066A	TRAY-STABILIZER	HIPS	1	1	1	1	1	1	1	SA
6-8	DB94-00458D	ASSY HOSE DRAIN	ASSY	1	1	1	1	1	1	1	SA
7	DB94-00455B	ASSY-RUBBER BEARING	ASSY	1	1	1	1	1	1	1	SA
8	DB94-01556B	ASSY-CROSS FAN	ASSY(AS+GF20%)	1	1	1	1	1	1	1	SA
9	DB31-00589A	MOTOR FAN	60HZ	1	1	1	1	1	1	1	SA
10	DB97-11889A	ASSY COVER TERMINAL	ABS	1	1	1	1	1	1	1	SA
11	DB61-01981C	HOLDER-PIPE	HIPS	1	1	1	1	1	1	1	SA
12	DB61-01978B	SUPPORT-EVAP	HIPS	1	1	1	1	1	1	1	SA
13	DB90-02738A	ASSY-PLATE HANGER	SGCC-M,T0.6	1	1	1	1	1	1	1	SA
14	DB93-11115K	ASSY REMOCON	ASSY	1	1	1	1	1	1	1	SA



MEMO





5-2 Outdoor Unit

■ AS18TSEAXXCH
 AS18TUBAXXAX
 AS18TUBAXXVN
 AS18TUBAXXAP

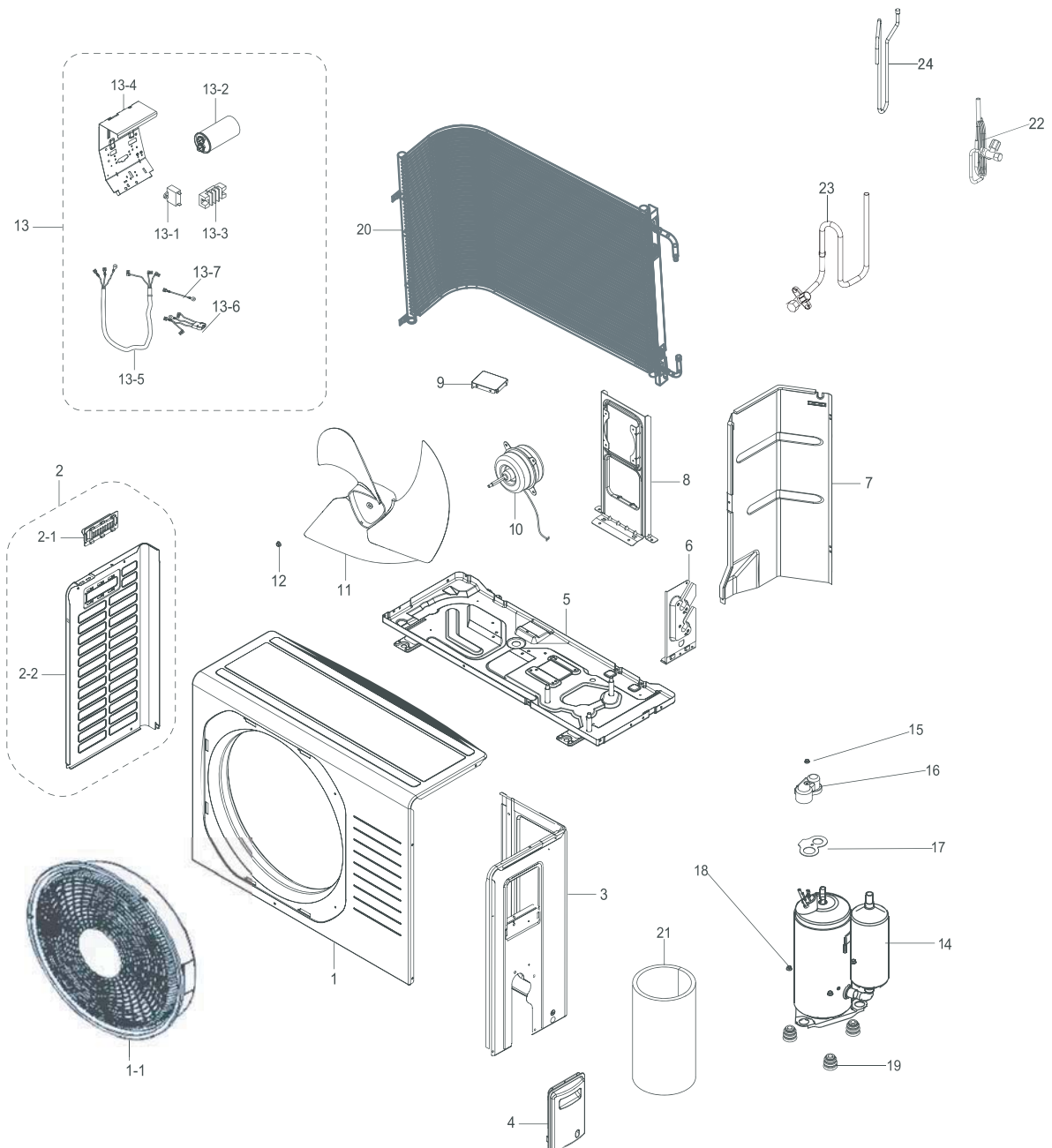

■ Parts List

NO.	CODE	Description	Specification	Q'TY		SA/SNA
				AS18TSEAXXCH	AS18TUBAXXAX AS18TUBAXXVN AS18TUBAXXAP	
1	DB90-03870T	ASSY CABI FRONT	ASSY	1	1	SA
1-1	DB63-02004A	GUARD-FAN	PP	1	1	SA
2	DB90-01332D	ASSY CABINET-SIDE LF	ASSY	1	1	SA
2-1	DB64-00992A	HANDLE-LF	PP	1	1	SA
2-2	DB64-00994D	CABINET-SIDE-LF	SECC-P	1	1	SA
3	DB90-01546W	ASSY CABINET-SIDE RH	ASSY	1	1	SA
4	DB90-04385A	ASSY COVER CONTROL	ASSY	1	-	SA
	DB90-03673E			-	1	SA
5	DB90-01330Q	ASSY BASE	ASSY	1	1	SA
6	DB99-00401A	ASSY VALVE-BRACKET	ASSY	1	1	SA
7	DB94-00668J	ASSY PARTITION	ASSY	1	1	SA
8	DB61-01644A	BRACKET MOTOR	ASSY	1	1	SA
9	DB97-02225N	ASSY-SUPPORT PLATE BM	ASSY	1	1	SA
10	DB31-00417G	MOTOR FAN	YDK95-45-4-3	1	1	SA
11	DB67-00397A	FAN-PROPELLER	AS+G/F20%,D400	1	1	SA
12	DB60-30004A	SCREW-MACHINE	M6,L12	1	1	SA
13	DB93-09179K	ASSY CONTROL OUT	ASSY	1	-	SA
	DB93-09179J			-	1	SA
13-1	2301-001912	C-FILM	2500nF,450V	1	1	SA
13-2	2501-001308	C-OIL	50uF,500V	1	-	SA
	2501-001238		50uF,500V	-	1	SA
13-3	DB65-00253M	TERMINAL BLOCK	PBT	1	1	SA
13-4	DB61-03988A	CASE-CONTROL OUT	SGCC-M,0.6T	1	1	SA
13-5	DB93-11255F	ASSY CONNECTOR WIRE	ASSY	1	1	SA
13-6	DB93-08236D	CONNECT WIRE-FAN	ASSY	1	1	SA
13-7	DB93-05262P	ASSY CONNECTOR WIRE-LEAD	ASSY	1	1	SA
14	UR8B180DTAEHSS	RCP	ASSY	1	-	SA
	UR8D185IUCEHSS			-	1	SA
15	6021-001142	NUT-HEXAGON FLANGE	M5	1	1	SA
16	DB63-02310A	COVER TERMINAL	N1250	1	1	SA
17	DB63-00817B	GASKET	SIR,T1.2	1	1	SA
18	DB60-00319A	FLANGE-NUT	M8	3	3	SA
19	DB63-02297B	GROMMET ISOLATOR	NR	3	3	SA
20	DB96-15332A	ASSY COND-AL UNIT	ASSY	1	1	SA
21	DB63-02029C	FELT-COMP SOUND A	FELT	1	1	SA
22	DB96-08521D	ASSY TUBE CAPELLARY	ASSY	1	1	SA
23	DB96-14721B	ASSY TUBE SUCTION	ASSY	1	-	SA
	DB96-14721A			-	1	SA
24	DB96-14655B	ASSY TUBE DISCHARGE	ASSY	1	-	SA
	DB96-14655A			-	1	SA

5-2 Outdoor Unit

■ AQ18TSAXSER/AQ18TUBAXXAX
 AQ18TSBXSER
 AQ18TSAX
 AQ18TSBX

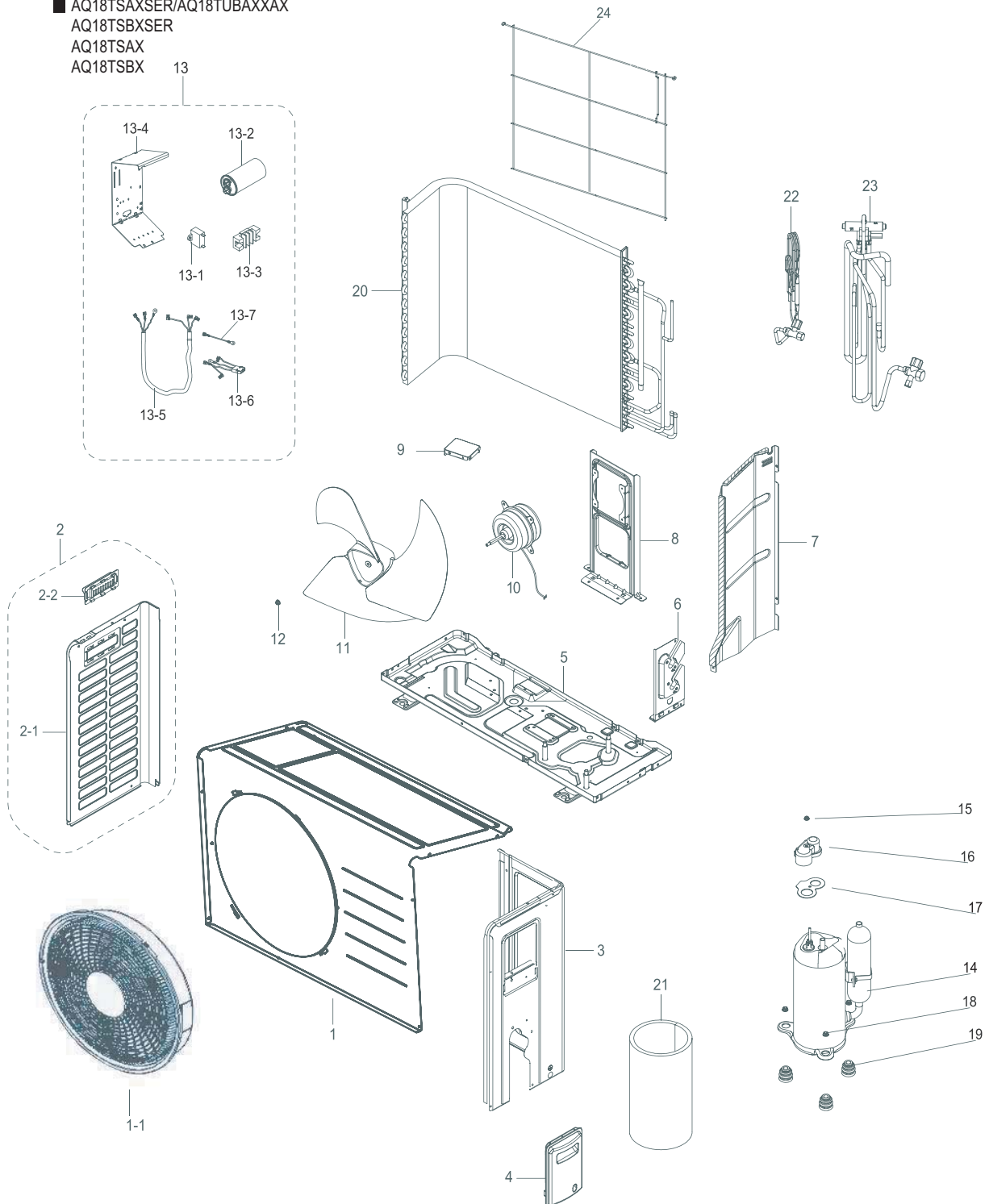

■ Parts List

NO.	CODE	Description	Specification	Q'TY			SA/SNA
				AQ18TSAXSER	AQ18TSBXSER AQ18TSAX AQ18TSBX	AQ18TUBAXXAX	
1	DB90-04398P	ASSY CABI FRONT	ASSY	1	-	1	SA
	DB90-04398C			-	1	-	SA
1-1	DB63-02004A	GUARD-FAN	PP	1	1	1	SA
2	DB90-01713A	ASSY CABINET-SIDE LF	ASSY	1	1	1	SA
2-1	DB64-00982A	CABINET-SIDE LF	SECC-P	1	1	1	SA
2-2	DB64-00992A	HANDLE-LF	PP	1	1	1	SA
3	DB90-02876R	ASSY CABINET-SIDE RH	ASSY	1	-	1	SA
	DB90-02876K			-	1	-	SA
4	DB90-03673E	ASSY COVER CONTROL	ASSY	1	1	1	SA
5	DB90-01681G	ASSY BASE OUT	ASSY	1	1	1	SA
6	DB61-02068A	BRACKET-VALVE	ASSY	1	1	1	SA
7	DB94-01919K	ASSY PARTITION	ASSY	1	1	1	SA
8	DB61-01644A	BRACKET MOTOR	ASSY	1	1	1	SA
9	DB97-02225L	ASSY-SUPPORT PLATE BM	ASSY	1	-	1	SA
	DB97-02225P			-	1	-	SA
10	DB31-00265E	MOTOR FAN	Y5S413B233	1	1	1	SA
11	DB67-00238A	FAN-PROPELLER	AS+G/F20%,D400	1	1	1	SA
12	DB60-30020A	UNT-HEXAGON FLANGE	M6.L12	1	1	1	SA
13	DB93-09178H	ASSY CONTROL OUT	ASSY	1	-	-	SA
	DB93-09178C			-	1	-	SA
	DB93-09178G			-	-	1	SA
13-1	2301-001912	C-FILM	2500nF,450V	1	1	1	SA
13-2	2501-001308	C-OIL	50uF,5000V	1	-	-	SA
	2501-001322		50uF,5000V	-	1	-	SA
	2501-001238		50uF,5000V	-	-	1	SA
13-3	DB65-00230D	TERMINAL BLOCK	PC	1	1	1	SA
13-4	DB61-03988A	PLATE-CONTROL OUT	SGCC-M,0.6T	1	1	1	SA
13-5	DB93-11255F	ASSY CONNECTOR WIRE	ASSY	1	-	1	SA
	DB93-08045F			-	1	-	SA
13-6	DB93-08236C	ASSY CONNECTOR WIRE-FAN	ASSY	1	1	1	SA
13-7	DB93-05262P	ASSY CONNECTOR WIRE-LEAD	ASSY	1	1	1	SA
14	UR8B200DUBEHSS	RCP	ASSY	1	-	-	SA
	G8D185JUAEH-SS			-	1	-	SA
	UR8D185IUCEHSS			-	-	1	SA
15	6021-001142	UNT-HEXAGON FLANGE	M5	1	1	1	SA
16	DB63-02310A	COVER TERMINAL	SABIC N1250	1	1	1	SA
17	DB63-00817B	GASKET	SIR,T1.2	1	1	1	SA
18	DB60-30028A	SCREW-HEX	SWRCH18A,M8	3	3	3	SA
19	DB63-02297B	GROMMET ISOLATOR	NR	3	3	3	SA
20	DB96-11105A	ASSY COND	ASSY	1	-	1	SA
	DB96-07128K			-	1	-	SA
21	DB63-02029C	FELT-COMP SOUND A	FELT	1	-	1	SA
	DB63-02029B			-	1	-	SA
22	DB96-11117D	ASSY TUBE CAPILLARY	ASSY	1	-	-	SA
	DB96-08525C			-	1	-	SA
	DB96-11117C			-	-	1	SA
23	DB96-11124C	ASSY-VALVE 4WAY	ASSY	1	-	-	SA
	DB96-12117A			-	1	-	SA
	DB96-14654A			-	-	1	SA
24	DB64-02118A	SCREEN-COND BAR	ASSY	1	1	1	SA



5-2 Outdoor Unit

■ AS24TSEAXXCH
 AS24TUBAXXAX
 AS24TUBAXXVN
 AS24TUBAXXAP

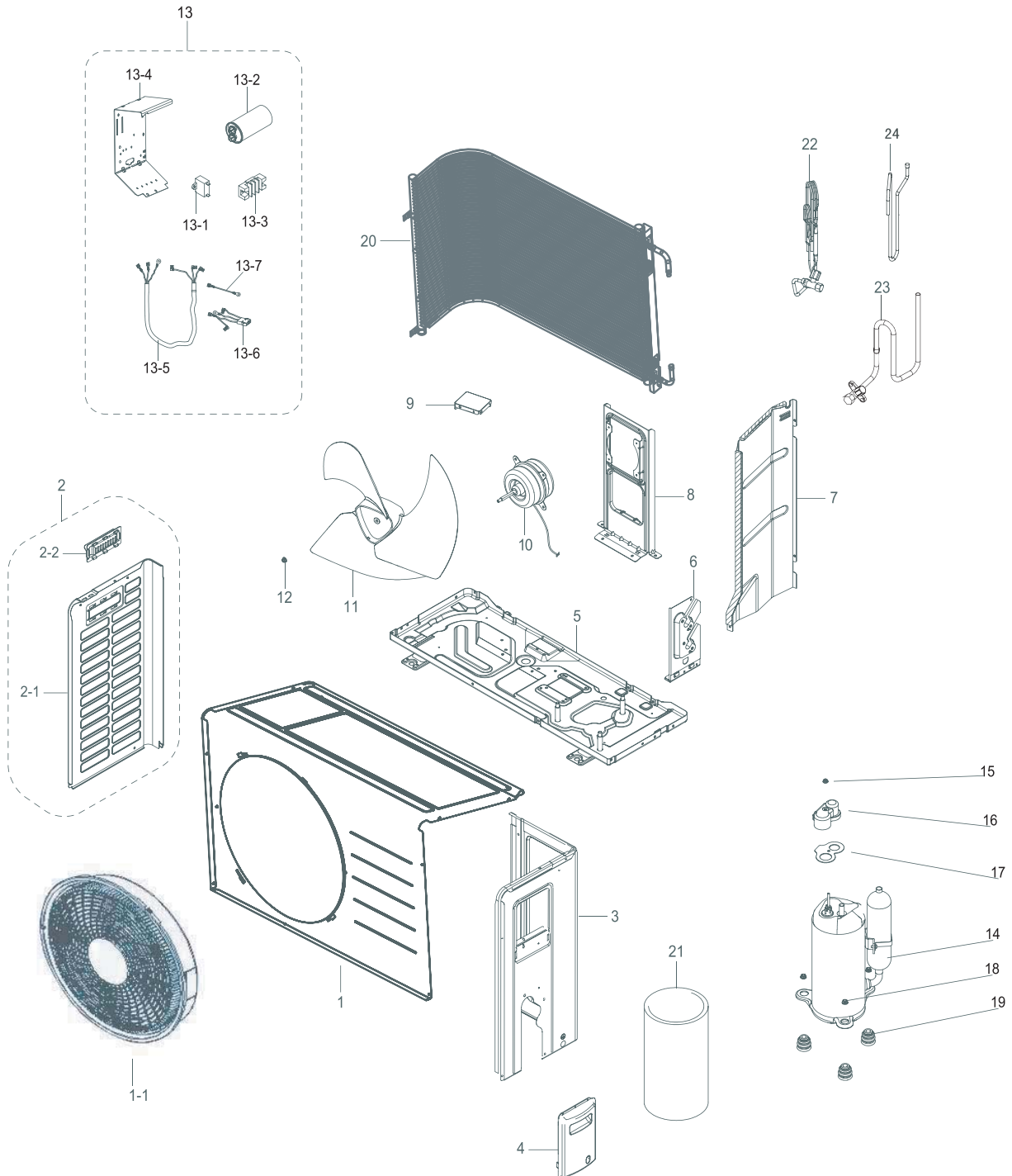

■ Parts List

NO.	CODE	Description	Specification	Q'TY		
				AS24TSEAXXCH	AS24TUBAXXAX AS24TUBAXXVN AS24TUBAXXAP	SA/SNA
1	DB90-04398C	ASSY CABI FRONT	ASSY	1	-	SA
	DB90-04398B			-	1	SA
1-1	DB63-02004A	GUARD-FAN	PP	1	1	SA
2	DB90-01713G	ASSY CABINET-SIDE LF	ASSY	1	1	SA
2-2	DB64-00982A	CABINET-SIDE LF	SECC-P	1	-	SA
	DB64-00982C			-	1	SA
2-1	DB64-00992A	HANDLE-LF	PP	1	1	SA
3	DB90-02876S	ASSY CABINET-SIDE RH	ASSY	1	1	SA
4	DB90-03673E	ASSY COVER CONTROL	ASSY	1	1	SA
5	DB90-01681M	ASSY BASE OUT	ASSY	1	1	SA
6	DB61-02068B	BRACKET-VALVE	ASSY	1	-	SA
	DB61-02068A			-	1	SA
7	DB94-01919K	ASSY PARTITION	ASSY	1	-	SA
	DB94-01919P			-	1	SA
8	DB61-01644A	BRACKET MOTOR	ASSY	1	1	SA
9	DB97-02225P	ASSY-SUPPORT PLATE BM	ASSY	1	1	SA
10	DB31-00265E	MOTOR FAN	YDK95-45-4-1	1	-	SA
	DB31-00265F			-	1	SA
11	DB67-00238A	FAN-PROPELLER	AS+G/F20%,D400	1	1	SA
12	DB60-30020A	UNT-HEXAGON FLANGE	M6,L12	1	1	SA
13	DB93-09179D	ASSY CONTROL OUT	ASSY	1	-	SA
	DB93-09179H			-	1	SA
13-1	2301-001912	C-FILM	2500nF,450V	1	1	SA
13-2	2501-001306	C-OIL	50uF,450V	1	-	SA
	2501-001239			-	1	SA
13-3	DB65-00253M	TERMINAL BLOCK	PC	1	1	SA
13-4	DB61-03988A	CASE-CONTROL OUT	SGCC-M,0.6T	1	1	SA
13-5	DB93-08045F	ASSY CONNECTOR WIRE	ASSY	1	1	SA
13-6	DB93-08236D	ASSY CONNECTOR WIRE-FAN	ASSY	1	1	SA
13-7	DB93-05262P	ASSY CONNECTOR WIRE-LEAD	ASSY	1	1	SA
14	UR5A250JUAEMSS	RCP	ASSY	1	-	SA
	UR5A240IUBEMSS			-	1	SA
15	6021-001142	UNT-HEXAGON FLANGE	M5	1	1	SA
16	DB63-02310A	COVER TERMINAL	SABIC N1250	1	1	SA
17	DB63-00817B	GASKET	SIR,T1.2	1	1	SA
18	DB60-30028A	SCREW-HEX	SWRCH18A,M8	3	3	SA
19	DB63-02331A	GROMMET ISOLATOR	NR	3	3	SA
20	DB96-12715B	ASSY COND-AL UNIT	ASSY	1	-	SA
	DB96-14336A			-	1	SA
21	DB62-09917A	INSULATION-SOUND	FELT	1	1	SA
22	DB96-04356R	ASSY TUBE CAPILLARY	ASSY	1	1	SA
23	DB96-14483A	ASSY TUBE SUCTION	ASSY	1	1	SA
24	DB96-14484A	ASSY TUBE DISCHARGE	ASSY	1	1	SA



5-2 Outdoor Unit

□ AQ24TSAXSER

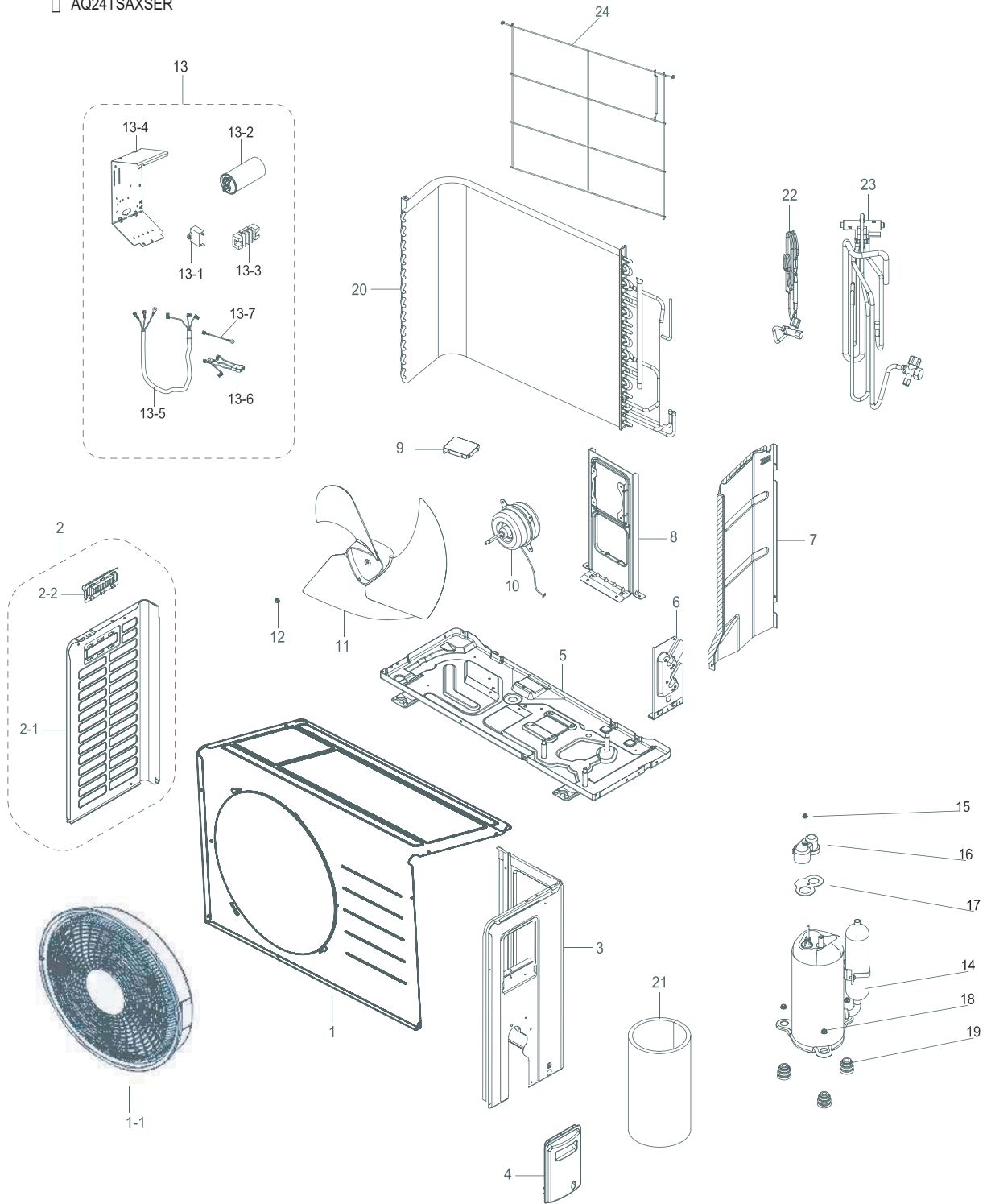

■ Parts List

NO.	CODE	Description	Specification	Q'TY	SA/SNA
				AQ24TSAXSER	
1	DB90-04398P	ASSY CABI FRONT	ASSY	1	SA
1-1	DB63-02004A	GUARD-FAN	PP	1	SA
2	DB90-01713A	ASSY CABINET-SIDE LF	ASSY	1	SA
2-1	DB64-00982A	CABINET-SIDE LF	SECC-P	1	SA
2-2	DB64-00992A	HANDLE-LF	PP	1	SA
3	DB90-02876R	ASSY CABINET-SIDE RH	ASSY	1	SA
4	DB90-03673E	ASSY COVER CONTROL	ASSY	1	SA
5	DB90-01681G	ASSY BASE OUT	ASSY	1	SA
6	DB61-02068A	BRACKET-VALVE	ASSY	1	SA
7	DB94-01919K	ASSY PARTITION	ASSY	1	SA
8	DB61-01644A	BRACKET MOTOR	ASSY	1	SA
9	DB97-02225L	ASSY-SUPPORT PLATE BM	ASSY	1	SA
10	DB31-00527A	MOTOR FAN	Y5S413B233	1	SA
11	DB67-00238A	FAN-PROPELLER	AS+G/F20%,D400	1	SA
12	DB60-30020A	UNT-HEXAGON FLANGE	M6,L12	1	SA
13	DB93-08342A	ASSY CONTROL OUT	ASSY	1	SA
13-1	2301-001913	C-FILM	4000nF,450V	1	SA
13-2	2501-001308	C-OIL	50uF, 500V	1	SA
13-3	DB65-00253A	TERMINAL BLOCK	PC	1	SA
13-4	DB61-02111B	PLATE-CONTROL OUT	SGCC-M,0.6T	1	SA
13-5	DB93-08045D	ASSY CONNECTOR WIRE	ASSY	1	SA
13-6	DB93-08236A	ASSY CONNECTOR WIRE-FAN	ASSY	1	SA
13-7	DB93-08021B	ASSY CONNECTOR WIRE-LEAD	ASSY	1	SA
14	UR5A250JUAEMSS	RCP	ASSY	1	SA
15	6021-001142	UNT-HEXAGON FLANGE	M5	1	SA
16	DB63-02310A	COVER TERMINAL	SABIC N1250	1	SA
17	DB63-00817B	GASKET	SIR,T1.2	1	SA
18	DB60-30028A	SCREW-HEX	SWRCH18A,M8	3	SA
19	DB63-02331A	GROMMET ISOLATOR	NR	3	SA
20	DB96-09897A	ASSY COND	ASSY	1	SA
21	DB62-09917A	FELT-COMP SOUND A	FELT	1	SA
22	DB96-09050C	ASSY TUBE CAPILLARY	ASSY	1	SA
23	DB96-14544A	ASSY-VALVE 4WAY	ASSY	1	SA
24	DB64-02118A	SCREEN-COND BAR	ASSY	1	SA



5-2 Outdoor Unit

■ AQ24TSBXSER
 AQ24TSAX
 AQ24TSBX
 AQ24TUBAXXAX

Exploded Views and Parts List

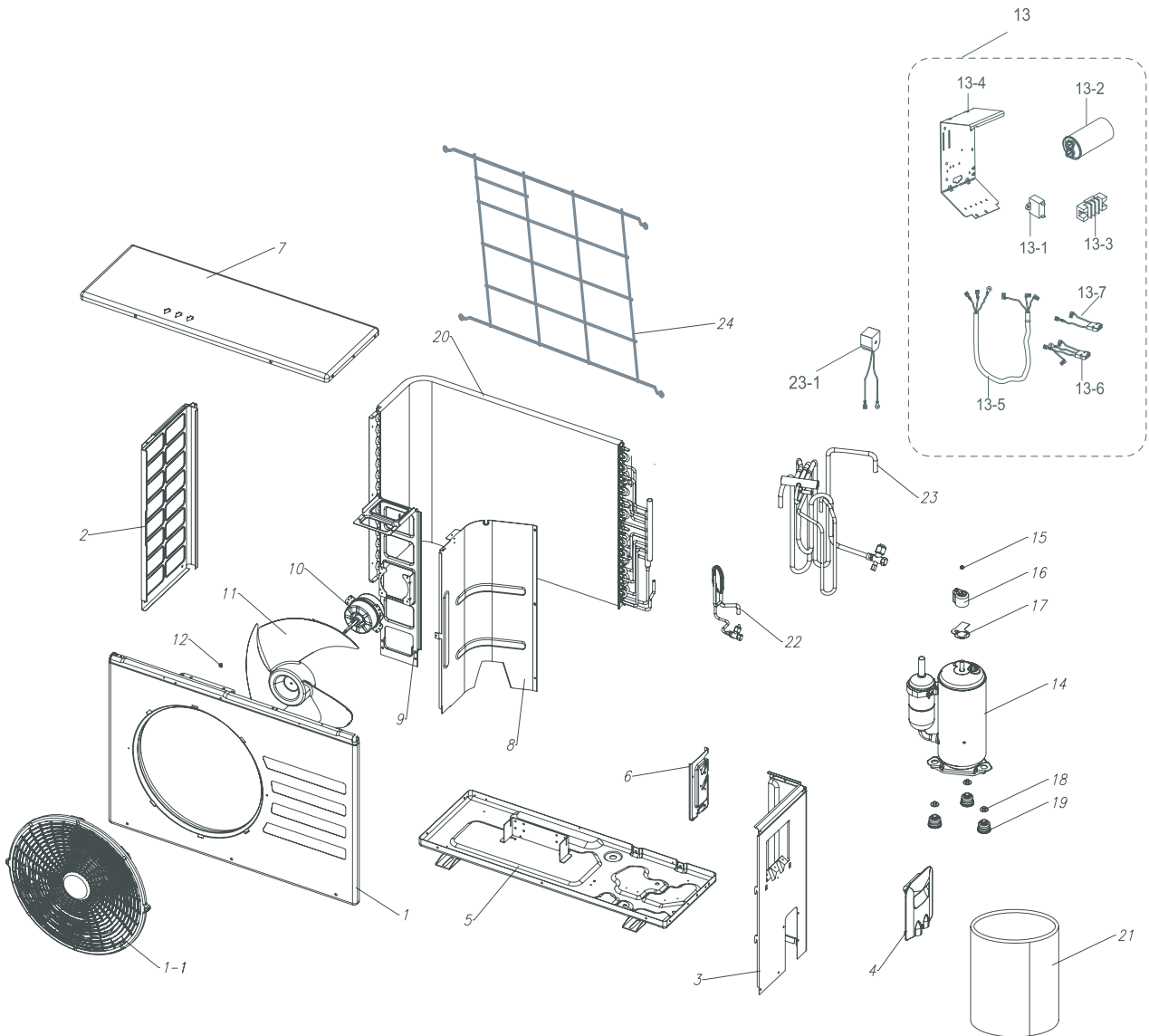

■ Parts List

NO.	CODE	Description	Specification	Q'TY		SA/SNA
				AQ24TSBXSER AQ24TSAX AQ24TSBX	AQ24TUBAXXAX	
1	DB90-03914E	ASSY CABI FRONT	ASSY	1	1	SA
1-1	DB63-00838A	GUARD-FAN	PP	1	1	SA
2	DB64-01064A	ASSY CABINET-SIDE LF	ASSY	1	1	SA
3	DB90-01651L	ASSY CABINET-SIDE RH	ASSY	1	1	SA
4	DB90-03652G	ASSY COVER CONTROL	ASSY	1	1	SA
5	DB90-00970V	ASSY BASE OUT	ASSY	1	1	SA
6	DB61-01593A	BRACKET-VALVE	ASSY	1	1	SA
7	DB90-10616T	ASSY CABI-UP	ASSY	1	-	SA
	DB90-10616G			-	1	SA
8	DB94-00649E	ASSY PARTITION	ASSY	1	1	SA
9	DB61-00686D	BRACKET MOTOR	ASSY	1	1	SA
10	DB31-00471A	MOTOR FAN	YDK95-45-4-1	1	-	SA
	DB31-00470A			-	1	SA
11	DB67-00142A	FAN-PROPELLER	AS+G/F20%,D400	1	1	SA
12	DB60-30020A	UNT-HEXAGON FLANGE	M6,L12	1	1	SA
13	DB93-08343B	ASSY CONTROL OUT	ASSY	1	-	SA
	DB93-08343G			-	1	SA
13-1	2301-001913	C-FILM	2500nF,450V	1	1	SA
13-2	2501-001320	C-OIL	45uF,4500V	1	-	SA
	2501-001239			-	1	SA
13-3	DB65-00253C	TERMINAL BLOCK	PC	1	1	SA
13-4	DB61-03528A	CASE-CONTROL OUT	SGCC-M,0.6T	1	1	SA
13-5	DB39-01037G	CONNECTOR WIRE-COMP	ASSY	1	1	SA
13-6	DB39-01033B	ASSY CONNECTOR WIRE-FAN	ASSY	1	1	SA
13-7	DB39-01035D	ASSY CONNECTOR WIRE	ASSY	1	1	SA
14	G5A240JUAEM-SS	RCP	ASSY	1	-	SA
	UR5A240IUBEMSS			-	1	SA
15	6021-001142	UNT-HEXAGON FLANGE	M5	1	1	SA
16	DB63-02310A	COVER TERMINAL	SABIC N1250	1	1	SA
17	DB63-00817B	GASKET	SIR,T1.2	1	1	SA
18	DB60-30028A	SCREW-HEX	SWRCH18A,M8	3	3	SA
19	DB63-00801B	GROMMET ISOLATOR	NR	3	3	SA
20	DB96-06018H	ASSY COND	ASSY	1	-	SA
	DB96-06017L			-	1	SA
21	DB62-06215A	INSULATION SOUND	FELT	1	1	SA
22	DB99-00787D	ASSY TUBE CAPILLARY	ASSY	1	-	SA
	DB96-14143C			-	1	SA
23	DB96-12116A	ASSY-VALVE 4WAY	ASSY	1	-	SA
	DB96-14477A			-	1	SA
24	DB64-02120A	SCREEN-COND BAR	ASSY	1	1	SA



MEMO



6. PCB Diagram and Parts List

6-1. PCB Diagram

6-1-1. Ass'y Control In

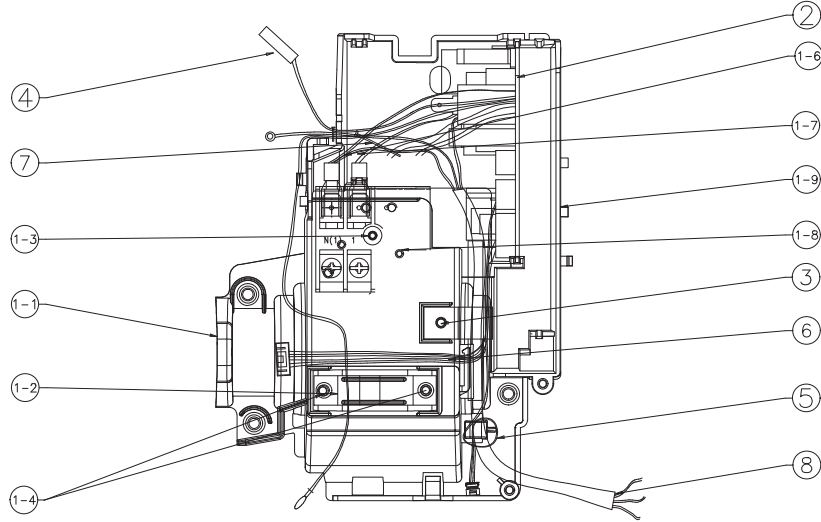

ASSY CONTROL IN CODE			DB93-10854A	DB93-10854B	DB93-10854C	DB93-10854D				
Model Code			MAX 18K H/P 1.2UF AQ18UUBEAXX	AS18TUBANXAX AS18TUBANXVN AS18TUBANXAP AS18UUBEAXX	MAX 18K H/P 1.2UF AQ18TWER	MAX 18K C/O 1.2UF AS18TSEAXCH				
NO	NAME	SPEC	CODE-NO	QTY	CODE-NO	QTY	CODE-NO	QTY	CODE-NO	QTY
1	ASSY CASE CONTROL IN		DB90-06305A	1	DB90-06305B	1	DB90-06305A	1	DB90-06305B	1
1-1	CASE CONTROL IN	ABS+PC+5V	DB61-04577A	1	←	1	←	1	←	1
1-2	HOLDER WIRE CLAMP		DB61-01097A	1	←	1	←	1	←	1
1-3	SCREW		6001-000929	1	←	1	←	1	←	1
1-4	SCREW		6002-000231	2	←	2	←	2	←	2
1-5	WIRE-POWER(N,OUTFAN,4WAY)	AWG #18 150mm 18K H/P A	DB93-10916B	1	←	0	←	1	←	0
1-6	WIRE-POWER(N)	AWG #18 150mm 18K C/O A	DB93-10916E	0	←	1	←	0	←	1
1-7	T/B(1) TO RY71(3)	BRN AWG #14 18K A POWER	DB93-05803B	1	←	1	←	1	←	1
1-8	TERMINAL BLOCK	[N(1),1,2,3]	DB65-00176D	1	←	0	←	1	←	0
		[N(1),1]	DB65-00061F	0	←	1	←	0	←	1
1-9	LABEL BAR CODE		DB68-02809A	1	←	1	←	1	←	1
2	ASS'Y PCB MAIN		DB93-10859A	1	DB93-10859D	1	DB93-10859A	1	DB93-10859D	1
3	SCREW		6002-000231	1	←	1	←	1	←	1
4	ASS'Y THERMISTOR		DB95-04570B	1	←	1	←	1	←	1
5	WIRE-STEP MOTOR	250mm, WHITE CONNECT	DB93-04688B	1	←	1	←	1	←	1
6	WIRE-MAIN TO DISPLAY	9PIN 200mm	DB93-10918C	1	←	1	←	1	←	1
7	CABLE TIE	100mm	DB65-10088D	1	←	1	←	1	←	1
8	ASS'Y POWER CORD	18K SER ;XCH	DB93-03038B	0	←	0	←	1	←	1
		XAX ;XAP ;18K A POWER	DB93-03038D	1	←	1	←	0	←	0
9	LBAL E BAR CODE		DB68-02809A	1	←	1	←	1	←	1

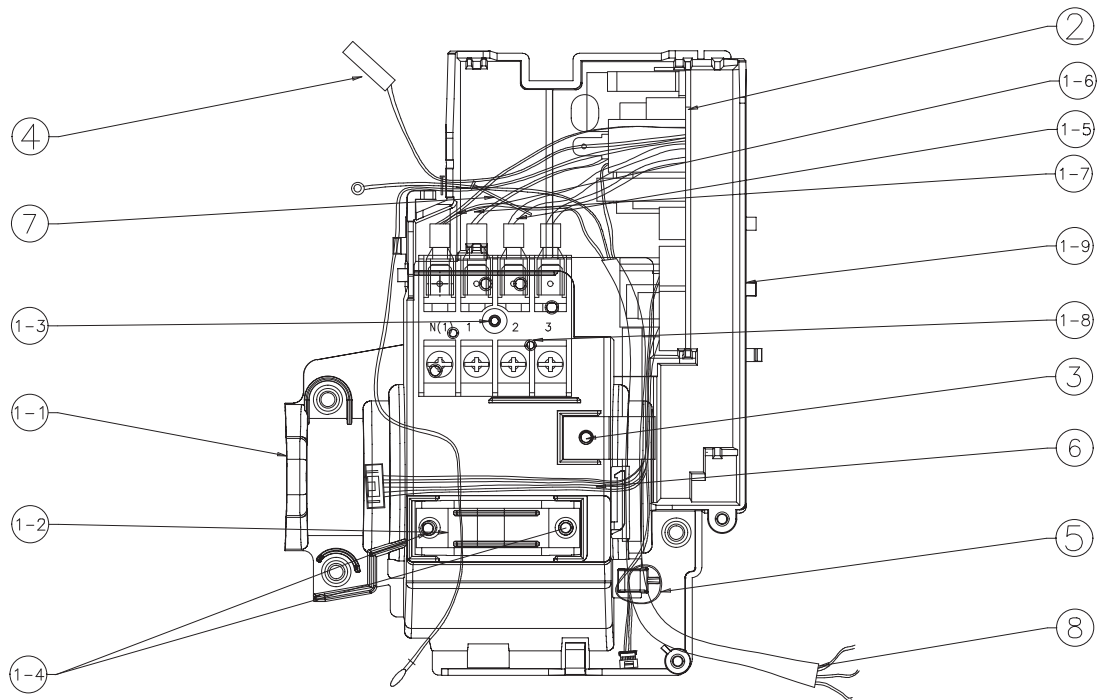

ASSY CONTROL IN CODE			DB93-10854A	DB93-10854B	DB93-10854C	DB93-10854D				
Model Code			AQ18TUBAXAX AQ18UUBEAXAX	MAX 18K C/O 1.2UF AS18UUBEXAX	MAX 18K H/P 1.2UF AS18TSAXCH	MAX 18K C/O 1.2UF AS18TSEAXCH				
NO	NAME	SPEC	CODE-NO	QTY	CODE-NO	QTY	CODE-NO	QTY	CODE-NO	QTY
1	ASSY CASE CONTROL IN		DB90-06305A	1	DB90-06305B	1	DB90-06305A	1	DB90-06305B	1
1-1	CASE CONTROL IN	ABS+PC+5V	DB61-04577A	1	←	1	←	1	←	1
1-2	HOLDER WIRE CLAMP		DB61-01097A	1	←	1	←	1	←	1
1-3	SCREW		6001-000929	1	←	1	←	1	←	1
1-4	SCREW		6002-000231	2	←	2	←	2	←	2
1-5	WIRE-POWER(N,OUTFAN,4WAY)	AWG #18 150mm 18K H/P A	DB93-10916B	1	←	0	←	1	←	0
1-6	WIRE-POWER(N)	AWG #18 150mm 18K C/O A	DB93-10916E	0	←	1	←	0	←	1
1-7	T/B(1) TO RY71(3)	BRN AWG #14 18K A POWER	DB93-05803B	1	←	1	←	1	←	1
1-8	TERMINAL BLOCK	[N(1),1,2,3]	DB65-00176D	1	←	0	←	1	←	0
		[N(1),1]	DB65-00061F	0	←	1	←	0	←	1
1-9	LABEL BAR CODE		DB68-02809A	1	←	1	←	1	←	1
2	ASS'Y PCB MAIN		DB93-10859A	1	DB93-10859D	1	DB93-10859A	1	DB93-10859D	1
3	SCREW		6002-000231	1	←	1	←	1	←	1
4	ASS'Y THERMISTOR		DB95-04570B	1	←	1	←	1	←	1
5	WIRE-STEP MOTOR	250mm, WHITE CONNECT	DB93-04688B	1	←	1	←	1	←	1
6	WIRE-MAIN TO DISPLAY	9PIN 200mm	DB93-10918C	1	←	1	←	1	←	1
7	CABLE TIE	100mm	DB65-10088D	1	←	1	←	1	←	1
8	ASS'Y POWER CORD	18K SER ;XCH	DB93-03038B	0	←	0	←	1	←	1
		XAX ;XAP ;18K,APOWER	DB93-03038D	1	←	1	←	0	←	0
9	LBALE BAR CODE		DB68-02809A	1	←	1	←	1	←	1



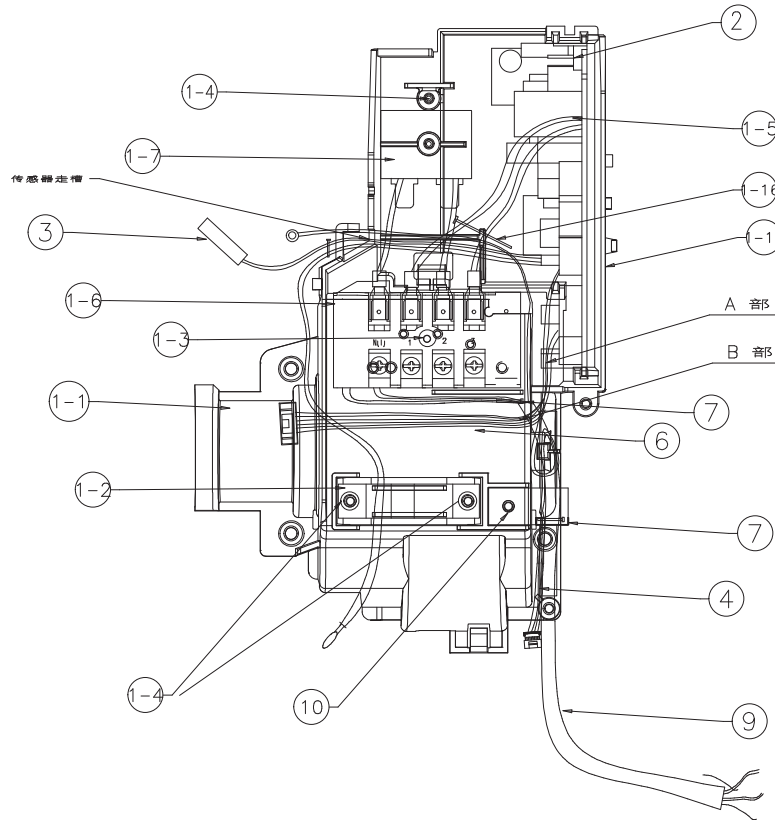

ASSY CONTROL IN CODE			DB93-10855A	DB93-10855B	DB93-10855C	DB93-10855D	DB93-10855E	DB93-10855F						
Model Code			24K H/P DEC. RELAY AQ24UBEXAX AQ24TWASER AQ24TUANGAR	AS24TUBANXAX AS24TUBANXVN AS24TUBANXAP AS24UBEXAX AS24TSEAXKH AS18TUANGAR AS24TUANGAR	24K H/P SANYOU RELAY AQ24UBEXAX AQ24TWASER AQ18TUANGAR AQ24TUANGAR	24K H/P SANYOU RELAY AS24UBEXAX AS24TSEAXKH AS18TUANGAR AQ24TUANGAR	18K H/P	18K CO						
NO	NAME	SPEC	CODE-NO	QTY	CODE-NO	QTY	CODE-NO	QTY	CODE-NO	QTY	CODE-NO	QTY		
1	ASSY CASE CONTROL IN		DB90-06306A	1	DB90-06306B	1	DB90-06306C	1	DB90-06306D	1	DB90-06306E	1	DB90-06306F	1
1-1	CASE CONTROL IN	ABS+PC+5V	DB61-04576A	1	DB61-04576A	1	DB61-04576A	1	DB61-04576A	1	DB61-04576A	1	DB61-04576A	1
1-2	HOLDER WIRE CLAMP		DB61-01097A	1	DB61-01097A	1	DB61-01097A	1	DB61-01097A	1	DB61-01097A	1	DB61-01097A	1
1-3	SCREW		6001-000929	1	6001-000929	1	6001-000929	1	6001-000929	1	6001-000929	1	6001-000929	1
1-4	SCREW		6002-000231	3	6002-000231	3	6002-000231	3	6002-000231	3	6002-000231	3	6002-000231	3
1-5	WIRE-POWER(N,OUTFAN,AWAY)	AWG #18 150mA H/P	DB93-10916B	1	DB93-10916B	0	DB93-10916B	0	DB93-10916B	0	DB93-10916B	0	DB93-10916B	0
1-5	WIRE-POWER(N)	AWG #18 150mA CO	DB93-10916E	0	DB93-10916E	0	DB93-10916E	0	DB93-10916E	0	DB93-10916E	0	DB93-10916E	0
1-6	TERMINAL BLOCK	[N,L,N(1),1,2,3]	DB65-00105Y	1	DB65-00105Y	0	DB65-00105Y	0	DB65-00105Y	0	DB65-00105Y	0	DB65-00105Y	0
1-6		[N,L,N(1),1]	DB65-00176G	0	DB65-00176G	0	DB65-00176G	0	DB65-00176G	0	DB65-00176G	0	DB65-00176G	0
1-6		[N(1),1,2,3]	DB65-00176D	0	DB65-00176D	0	DB65-00176D	0	DB65-00176D	0	DB65-00176D	0	DB65-00176D	0
1-6		[N(1),1]	DB65-00061F	0	DB65-00061F	0	DB65-00061F	0	DB65-00061F	0	DB65-00061F	0	DB65-00061F	1
1-7	RELAY POWER	30A	3501-001335 SANYOU RELAY	1 0	3501-001335 SANYOU RELAY	1 0	3501-001335 SANYOU RELAY	1 0	3501-001335 SANYOU RELAY	1 0	3501-001335 SANYOU RELAY	1 0	3501-001335 SANYOU RELAY	1 0
1-8	C/W 1/B(N) TO 1/B (N(1))	mm AWG#14, SKY/BLU	DB93-04339J	1	DB93-04339J	1	DB93-04339J	1	DB93-04339J	1	DB93-04339J	1	DB93-04339J	0
1-9	C/W 1/B(1) TO 30A-RELAY(4)	mm AWG#14, RED	DB93-04339K	1	DB93-04339K	1	DB93-04339K	1	DB93-04339K	1	DB93-04339K	1	DB93-04339K	0
1-10	C/W 1/B (L) TO 30A-RELAY(1)	mm AWG#14, RED	DB93-04339K	1	DB93-04339K	1	DB93-04339K	1	DB93-04339K	1	DB93-04339K	1	DB93-04339K	0
1-11	C/W 1/B(N) TO 30A-RELAY(6)	mm AWG#16, SKY/BLU	DB93-04339L	1	DB93-04339L	1	DB93-04339L	1	DB93-04339L	1	DB93-04339L	1	DB93-04339L	0
1-12	C/W 1/B(L) TO 25A-RELAY(4)	mm AWG#16, BRN	DB93-04339T	1	DB93-04339T	1	DB93-04339T	1	DB93-04339T	1	DB93-04339T	1	DB93-04339T	0
1-13	C/W 25A-RELAY(3) TO 30A-RELAY(5)	mm AWG#16, BRN	DB93-04339N	1	DB93-04339N	1	DB93-04339N	1	DB93-04339N	1	DB93-04339N	1	DB93-04339N	0
1-14	C/W TO RELAY	mm AWG#14, BRN	DB93-04339V	0	DB93-04339V	0	DB93-04339V	2	DB93-04339V	2	DB93-04339V	0	DB93-04339V	0
1-15	C/W TO PBA 12V CONNECT	12V, BLK	DB93-11195A	0	DB93-11195A	0	DB93-11195A	1	DB93-11195A	1	DB93-11195A	0	DB93-11195A	0
1-16	CABLE-TIE	100mm	DB65-10088D	1	DB65-10088D	1	DB65-10088D	1	DB65-10088D	1	DB65-10088D	1	DB65-10088D	1
1-17	1/B(1) TO RY71(3)	BRN, AWG #14, 18K, A POWER	DB93-05803B	0	DB93-05803B	0	DB93-05803B	0	DB93-05803B	0	DB93-05803B	1	DB93-05803B	1
1-18	LABLE BAR CODE	W175 L115	DB68-02809A	1	DB68-02809A	1	DB68-02809A	1	DB68-02809A	1	DB68-02809A	1	DB68-02809A	1
2	ASS'Y PCB MAIN		DB93-10860A	1	DB93-10860B	1	DB93-10860C	1	DB93-10860D	1	DB93-10860A	1	DB93-10860B	1
3	ASS'Y THERMISTOR	9/12K 24K	DB95-04570A	1	DB95-04570A	1	DB95-04570A	1	DB95-04570A	1	DB95-04570A	1	DB95-04570A	1
4	WIRE-STEP MOTOR	250mm, WHT CONNECT	DB93-04688B	1	DB93-04688B	1	DB93-04688B	1	DB93-04688B	1	DB93-04688B	1	DB93-04688B	1
5	MPI CONNECTOR WIRE	100mm	DB93-04695B	0	DB93-04695B	0	DB93-04695B	0	DB93-04695B	0	DB93-04695B	0	DB93-04695B	0
6	WIRE-MAIN TO DISPLAY	9P1N 200mm	DB93-10918C	1	DB93-10918C	1	DB93-10918C	1	DB93-10918C	1	DB93-10918C	1	DB93-10918C	1
7	CABLE-TIE	100mm	DB65-10088D	2	DB65-10088D	2	DB65-10088D	2	DB65-10088D	2	DB65-10088D	2	DB65-10088D	2
8	LABLE BAR CODE	W175 L115	DB68-02809A	1	DB68-02809A	1	DB68-02809A	1	DB68-02809A	1	DB68-02809A	1	DB68-02809A	1
9	POWER CORD	24K SER:WHT;W/P MAX	DB93-06555B	1	DB93-06555B	1	DB93-06555B	1	DB93-06555B	1	DB93-06555B	0	DB93-06555B	0
9		18K GAR	DB93-01549C	0	DB93-01549C	0	DB93-01549C	0	DB93-01549C	0	DB93-01549C	1	DB93-01549C	1
10	SCREW		6002-000231	1	6002-000231	1	6002-000231	1	6002-000231	1	6002-000231	1	6002-000231	1



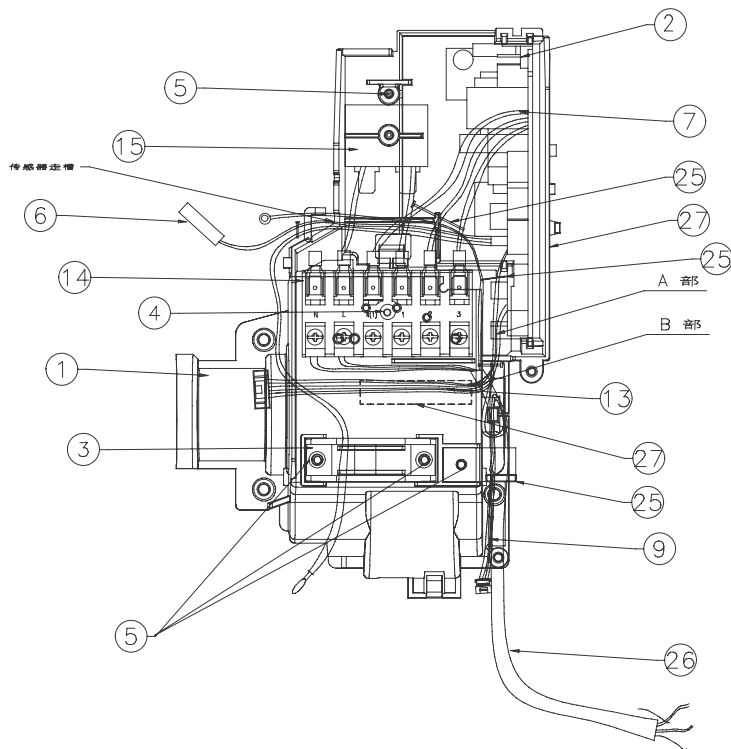

ASSY CONTROL IN CODE			DB93-10855A	DB93-10855B	DB93-10855C	DB93-10855D	DB93-10855E	DB93-10855F						
Model Code			AQ24TSBNSER AQ24TSAN AQ24UBEXAX AQ24TWASER AQ18TUANGAR AQ24TUANGAR	24K C/O DEC. RELAY AS24UUBEXAX AS24TSEAXCH AS18TUANGAR AS24TUANGAR	24K H/P SANYOU RELAY AQ24UUBEXAX AQ24TWASER AQ18TUANGAR AQ24TUANGAR	24K H/P SANYOU RELAY AQ24UUBEXAX AS24TEAXCH AS18TUANGAR AS24TUANGAR	AQ24TUBANXAX AQ24TSASER AQ18TSBNSER AQ18TSAN AQ18TSBN	18K CO						
NO	NAME	SPEC	CODE-NO	QTY	CODE-NO	QTY	CODE-NO	QTY	CODE-NO	QTY	CODE-NO	QTY		
1	ASSY CASE CONTROL IN		DB90-06306A	1	DB90-06306B	1	DB90-06306C	1	DB90-06306D	1	DB90-06306E	1	DB90-06306F	1
1-1	CASE CONTROL IN	ABS+PC+5V	DB61-04576A	1	DB61-04576A	1	DB61-04576A	1	DB61-04576A	1	DB61-04576A	1	DB61-04576A	1
1-2	HOLDER WIRE CLAMP		DB61-01097A	1		1		1		1		1		1
1-3	SCREW		6001-000929	1		1		1		1		1		1
1-4	SCREW		6002-000231	3		3		3		3		3		3
1-5	WIRE-POWER(N,OUTFAN,HWAY)	AWG #18 150mm,A H/P	DB93-10916B	1		0		1		0		1		0
	WIRE-POWER(N)	AWG #18 150mm,A CO	DB93-10916E	0		1		0		1		0		1
1-6	TERMINAL BLOCK	[N,L,N(1),1,2,3]	DB65-00105Y	1		1		1		0		0		0
		[N,L,N(1),1]	DB65-00176G	0		1		0		1		0		0
		[N(1),1,2,3]	DB65-00176D	0		0		0		0		1		0
		[N(1),1]	DB65-00061F	0		0		0		0		0		1
1-7	RELAY POWER	30A	3501-001335	1		1		0		0		0		0
			SANYOU RELAY	0		0		1		1		0		0
1-8	C/W T/B(N) TO T/B (N(1))	mm AWG#14,SKY/BLU	DB93-04339J	1		1		1		1		0		0
1-9	C/W T/B(1) TO 30A-RELAY(4)	mm AWG#14,RED	DB93-04339K	1		1		0		0		0		0
1-10	C/W T/B (L) TO 30A-RELAY(1)	mm AWG#14,RED	DB93-04339K	1		1		0		0		0		0
1-11	C/W T/B(N) TO 30A-RELAY(6)	mm AWG#16,SKY/BLU	DB93-04339L	1		1		0		0		0		0
1-12	C/W T/B(L) TO 25A-RELAY(4)	mm AWG#16,BRN	DB93-04339T	1		1		0		0		0		0
1-13	C/W 25A-RELAY(3) TO 30A-RELAY(5)	mm AWG#16,BRN	DB93-04339N	1		1		0		0		0		0
1-14	C/W TO RELAY	mm AWG#14,BRN	DB93-04339V	0		0		2		2		0		0
1-15	C/W TO PBA 12V CONNECT	12V, BLK	DB93-11195A	0		0		1		1		0		0
1-16	CABLE-TIE	100mm	DB65-10088D	1		1		1		1		1		1
1-17	T/B(1) TO R7Y(3)	BRN,AWG #14,18K,A POWER	DB93-05803B	0		0		0		0		1		1
1-18	TABLE BAR CODE	W175 L115	DB68-02809A	1		1		1		1		1		1
2	ASS'Y PCB MAIN		DB93-10860A	1	DB93-10860B	1	DB93-10860C	1	DB93-10860D	1	DB93-10860A	1	DB93-10860B	1
3	ASS'Y THERMISTOR	9/12K 24K	DB95-04570A	1		1		1		1		1		1
4	WIRE-STEP MOTOR	250mm,WHI CONNECT	DB93-04688B	1		1		1		1		1		1
5	MPI CONNECTOR WIRE	100mm	DB93-04695B	0		0		0		0		0		0
6	WIRE-MAIN TO DISPLAY	9P1N 200mm	DB93-10918C	1		1		1		1		1		1
7	CABLE-TIE	100mm	DB65-10088D	2		2		2		2		2		2
8	TABLE BAR CODE	W175 L115	DB68-02809A	1		1		1		1		1		1
9	POWER CORD	24K SER-2CH,MAP MAX 18K GAR	DB93-06555B	1		1		1		1		0		0
			DB93-01549C	0		0		0		0		1		1
10	SCREW		6002-000231	1		1		1		1		1		1



6-1-2. Indoor MAIN PCB

AQ18*AS18*

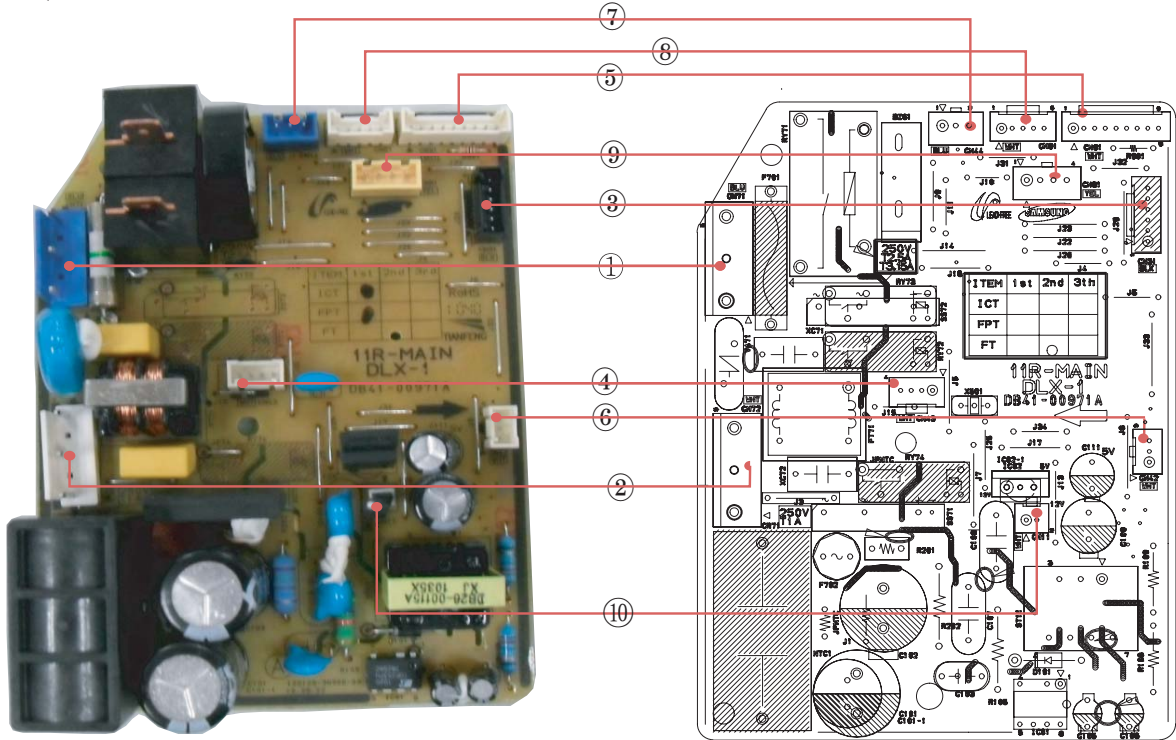

<p>①CN71(L -terminal) Power Input #1:POWER #2:LOAD CONTROL signal #3:LOAD CONTROL signal</p>	<p>②CN72-FAN MOTOR #1:Motor start Capacitor connect #3:AC phase control signal #5:Power</p>	<p>③CN31-DOWNLOAD #1:TEST #2:Vcc #3:GND #4:RESET #5:SDAT #6:SCLK</p>	<p>④CN43-TEMPERATURE SENSOR #1:Room temperature sensing #2:GND #3:Pipe temperature sensing #4:GND</p>
<p>⑤CN91-DISPLAY #1:DIO #2:CLK #3:STB #4:IRQ #5:GND #6:Vcc #7:Vovt #8:PWM_LED #9: ROOM-TEMP</p>	<p>⑥CN42-Humidity sensor #1:Output(P1) #2:Input #3:Output(P2)</p>	<p>⑦CN44-FAN MOTOR FEEDBACK #1:DC5V #2:GND #3:Feedback signal input</p>	<p>⑧CN61-STEP MOTOR #1:DC12V #2:Motor driving signal output_1 #3:Motor driving signal output_2 #4:Motor driving signal output_3 #5:Motor driving signal output_4</p>
<p>⑨CN81-SPI #1:MPI driving signal output (+) #3:DV12V</p>	<p>⑩CN11-12V CONNECT #1: SMPS Vovt(12V) #2:7805 INPUT(12V)</p>		

AS24*/AQ24*

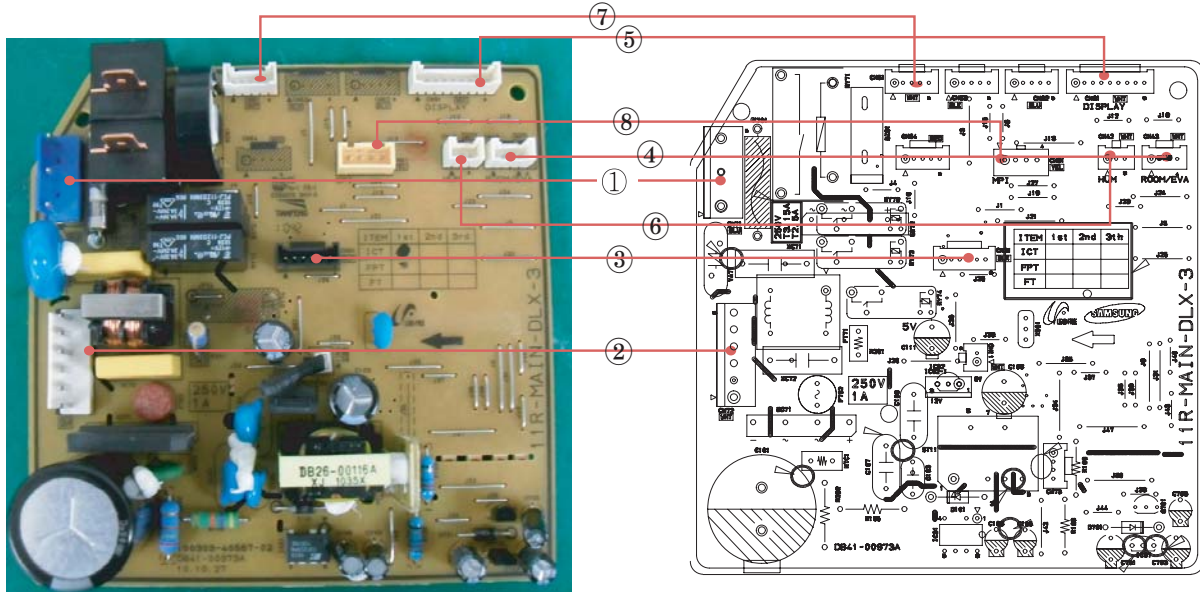

<p>①CN71(L-terminal) Power Input #1:Power #2:Load control signal #3:Load control signal</p>	<p>②CN72- MOTOR #1:POWER(310V) #3:ACND #4:Vcc #5:PWM #6:PWM-F/B</p>	<p>③CN31-DOWNLOAD #1:TEST #2:Vcc #3:GND #4:RESET #5:SDAT #6:SCLK</p>	<p>④CN43-TEMPERATURE SENSOR #1:Room temperature sensing #2:GND #3:Pipe temperature sensing #4:GND</p>
<p>⑤CN91-DISPLAY #1:DIO #2:CLK #3:STB #4:IRQ #5:GND #6:Vcc #7:Vovt #8:PWM_LED #9: ROOM-TEMP</p>	<p>⑥CN42-Humidity sensor #1:Output(P1) #2:Input #3:Output(P2)</p>	<p>⑦CN61-STE PMOTOR #1:DC12V #2:Motor driving signal output_1 #3:Motor driving signal output_2 #4:Motor driving signal output_3 #5:Motor driving signal output_4</p>	<p>⑧CN81-SPI #1:MPI driving signal output (-) #3:DV12V</p>

6-1-3. Indoor Display PCB



<p>#1:DIO #2:CLK #3:STB #4:IRQ #5:GND #6:Vcc #7:Vout #9:NTC01</p>

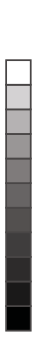

6-2. Electrical Part List

■ MAIN PCB

NO	CODE	DESC. SPEC	PARA1	PARA2	LOCATION	BLOCK	DB93-10859A	DB93-10859D
1	0841-00971A	PCB, 90°120mm FR-1			MAIN PCB	PCB	1	1
2	3711-00437R	BOX 4P 1R 2mm STRAIGHT SN.WHT			CONNECTION	CN43	1	1
3	2007-001068	5.8kohm 1% 1/10W TP 1608		SMW200-04P	R-CHIP	R401	1	1
4	2007-001069	8.8kohm 1% 1/10W TP 1608		8.8kohm 1608	R-CHIP	R402	1	1
5	2007-000076	330ohm 5%, 1/10W TP 1608		330ohm 1608	R-CHIP	R403	1	1
6	2007-000076	330ohm 5%, 1/10W TP 1608		330ohm 1608	R-CHIP	R404	1	1
7	2203-005249	C-CHIP 10% 50V X7R TP 1000F		1000F 1608	C-CHIP	C401	1	1
8	2203-005249	C-CHIP 10% 50V X7R TP 1000F		1000F 1608	C-CHIP	C402	1	1
9	1103-001431	AT24C08BN 8Kbit, 1Kx8 SOP 8P 4.9x3.9mm, 1.8/5.5 -40to+85C 18uA TP		AT24C08BN 8Kbit	IC-EEPROM	IC03	1	1
10	2007-000084	4.7kohm 5%, 1/10W TP 1608		4.7kohm 1608	R-CHIP	R502	1	1
11	2007-000084	4.7kohm 5%, 1/10W TP 1608		4.7kohm 1608	R-CHIP	R503	1	1
12	2007-000084	4.7kohm 5%, 1/10W TP 1608		4.7kohm 1608	R-CHIP	R504	1	1
13	3002-001129	BUZZER-PIEZO 85dB, -2KHZ		CBE220BPC / TDP-220FP	BUZZER	BZ21	1	1
14	2007-000076	R-CHIP 330ohm 5%, 1/10W TP 1608		330ohm 1608	R-CHIP	R601	1	1
15	2007-000076	R-CHIP 330ohm 5%, 1/10W TP 1608		330ohm 1608	R-CHIP	R602	1	1
16	0501-000534	TR-SMALL SIGNAL 25C2412K NPN 200mW SOT-23 TP 180-		25C2412K	TR-SMALL SIGNAL	Q601	1	1
17	3711-000978	SMW200-03		2K-1	CONNECT	CN44	1	1
18	2007-000078	R-CHIP 1kohm 5%, 1/10W TP 1608		IC REPLY TERMINAL	R-CHIP	R405	1	1
19	2007-000097	R-CHIP 8.8kohm 5%, 1/10W TP 1608		8.8K-J	R-CHIP	R406	1	1
20	2007-000098	R-CHIP 1kohm 5%, 1/10W TP 1608		1K-J	R-CHIP	R407	1	1
21	0501-000534	TR-SMALL SIGNAL 25C2412K NPN 200mW SOT-23 TP 180-		25C2412K	TR-SMALL SIGNAL	Q401	1	1
22	2203-000257	C-CER CHIP 10% 10V X7R TP 1000F		1000F	C-CHIP	C403	1	1
23	0806-000175	TR-ARRAY 2003 NPN, 7 1W SOT-16 ST 1000		ULN2003D013TR	TR-ARRAY	IC05	1	1
24	2203-005249	C-CER CHIP 10% 10V X7R TP 1000F		1000F 1608	C-CHIP	C504	1	1
25	3711-004484	SMW200-05		STEP MOTOR CONNECTOR	CONNECT	CN81	1	1
26	2203-005249	100nF 10% 50V X7R TP 1000F		1000F 1608	C-CER CHIP	C201	1	1
27	0804-001172	PHOTO-COUPLER		1LF181-GRH-TPL	PHOTO-COUPLER	PC02	1	1
28	2007-000084	R-CHIP		4.7K-J	R-CHIP	R205	1	1
29	2007-000078	R-CHIP		1Kohm 5%	R-CHIP	R206	1	1
30	3711-001087	SMW200-06		DOWNLOAD CONNECT	CONNECT	CN81	1	1
31	2203-005249	100nF 10% 50V X7R TP 1608		1000F 1608	C-CHIP	C301	1	1
32	2203-005249	100nF 10% 50V X7R TP 1608		1000F 1608	C-CHIP	C303	1	1
33	2007-000084	4.7kohm 5%, 1/10W TP 1608		4.7kohm 1608	R-CHIP	R301	1	1
34	2007-000084	4.7kohm 5%, 1/10W TP 1608		4.7kohm 1608	R-CHIP	R302	1	1
35	2007-000078	1Kohm 5%		1.0Kohm 1608	R-CHIP	R304	1	1
36	2007-001318	R-CHIP 1Kohm 5%, 1/4W TP 3216		1.0Kohm 3216	R-CHIP	R305	1	1
37	2007-000090	10kohm 5%, 1/10W TP 1608		10kohm 1608	R-CHIP	R306	1	1
38	1203-006245	IC-VOL DETECTOR		KA7033AT TSM 3P	RESETIC	IC06	1	1
39	2007-000078	1Kohm 5%		1.0Kohm 1608	R-CHIP	R303	1	1
40	2203-005249	100nF 10% 50V X7R TP 1000F		1000F 1608	C-CHIP	C202	1	1
41	2007-000109	R-CHIP 1Mohm 5%, 1/10W TP 1608		1Mohm 1608	R-CHIP	R501	1	1
42	2802-001198	RESONATOR-CERAMIC 10MHZ 0.5% BK 8X3X5.5MM		10MHZ	RESONATOR-CERAMIC	X501	1	1
43	DB91-01181A	ICOM			ASSY-MIC	IC04	1	1
44	DB09-00588A	IC MICOM		S3F84VBX2Z-QT8B	IC MICOM	IC04-1	1	1
45	2203-000257	10nF 10% 50V X7R TP 1608		10nF 1608	C-CHIP	C601	1	1
46	2203-005249	100nF 10% 50V X7R TP 1000F		1000F 1608	C-CHIP	C502	1	1
47	2203-005249	100nF 10% 50V X7R TP 1000F		1000F 1608	C-CHIP	C503	1	1
48	3501-001268	RELAY-POWER 12V 0.9W 25000mA SPST 20ms 10ms		RELAY	RY21	1	1	1
49	3711-000262	AC MOTOR CONNECT		YVW39E-05AV	CONNECT	CN72	1	1
50	3502-001115	SSR		AQ322212	SSR	CS71	1	1
51	2001-000429	1Kohm 5%, 1/8W AA TP 1.8x3.2mm		4K7kohm 1608	R-CARBON	R901	1	1
52	2007-000097	R-CHIP 4.7kohm 5%, 1/10W TP 1608		4.7kohm 1608	R-CHIP	R902	1	1
53	2203-000440	C-CER CHIP 1% 10V X7R TP 1608		1000F 1608	C-CHIP	C901	1	1
54	1405-000160	VARISTOR-680V 4500A 17.5x6.5mm TP INR14D681KORSV		NR14D681 / GNR14D681K 7.5mm	VARISTOR	VA71	1	1
55	DB67-00942A	VARISTOR CAP		PROTECT	VARISTOR-CAP	VA71-CAP	1	1
56	2301-000302	100nF 10% 25V		12 33X3.0	C-FILM	MC02	1	1
57	DB97-00517A	COIL CHOKE-J-094-15mh		JL-094-15mh	C-CHOKE	CT74	1	1
58	3601-001209	FUSE-RADIAL LEAD 250V 1A TIME LAG - 8.5x8mm		LT-6-010-H	FUSE-RADIAL LEAD	F702	1	1
59	0402-001298	DIODE-BRIDGE DP06S 800V 1A SMD-4 TP		DF06S	DIODE-BRIDGE	BD71	1	1
60	2003-000706	47kohm 5% 2W AA TP 4.3x15mm		C-CERAMIC DISC	R-METAL OXIDE(S)	R105	1	1
61	2201-000983	C-CERAMIC DISC		1NF 10% 2KV	C-CERAMIC	C103	1	1
62	2007-000781	R-CHIP 330ohm 5%, 1/8W TP 2012		33-	R-CHIP	R106	1	1
63	0402-000137	DIODE-RECTIFIER 1N4007 1KV 1A DO-41 TP		1N4007	DIODE-RECTIFIER	D101	1	1
64	0402-001427	DIODE-RECTIFIER-ES1D 200V 1A DO-214AC TP		ES1D	DIODE-RECTIFIER	D102	1	1
65	0402-001192	ES2D 200V 2A SMD TP		ES2D	DIODE-RECTIFIER	D103	1	1
66	2201-000987	C-CERAMIC DISC		2.2nF	400V	C107	1	1
67	2201-000987	C-CERAMIC DISC		2.2nF	400V	C108	1	1
68	2401-001998	C-AL		1000uF 20% 25V GP TP 10x20.5mm	C-AL	C109	1	1
69	2203-005249	100nF 10% 50V X7R TP 1000F		1000F 1608	C-CER CHIP	C110	1	1
70	2401-000800	C-AL		220uF 20% 16V GP TP 8x11.5	C-AL	C111	1	1
71	2203-005249	100nF 10% 50V X7R TP 1000F		1000F 1608	C-CER CHIP	C112	1	1
72	2203-005249	100nF 10% 50V X7R TP 1000F		1000F 1608	C-CER CHIP	C113	1	1
73	2203-005249	100nF 10% 50V X7R TP 1000F		1000F 1608	C-CER CHIP	C104	1	1
74	2401-002619	C-AL		47uF 20% 25V GP TP 5x11.5	C-AL	C105	1	1
75	2401-000480	C-AL		10uF 20% 50V GP TP 5x11.5	C-AL	C106	1	1
76	2007-001074	R 8.8ohm 5%, 1/8W TP 2012		8.8kohm 2012	R-CHIP	R107	1	1
77	2007-000074	100ohm 5%, 1/10W TP 1608		100ohm 1608	R-CHIP	R110	1	1
78	2007-000081	2.7kohm 5%, 1/10W TP 1608		2.7kohm 1608	R-CHIP	R111	1	1
79	2007-000077	R-CHIP		47K-J	R-CHIP	R112	1	1
80	1203-006089	IC-PWM CONTROLLER		TP253PN DIP 7P 6.35x9 57mm PLAS	1/10W 1608	IC01	1	1
81	DB26-00115A	TRANS		TLF181-GB		ST11	1	1
82	0804-001002	PHOTO-COUPLER TR 100-600V 200mW SOD-4 TP		TLF181-GB	PHOTO	PC01	1	1
83	0504-001064	TR-DIGITAL		DTC114EKA	200mW	D101	1	1
84	0403-001285	DIODE-ZENER		BZX84-C11	11V/360mW	ZD01	1	1
85	0403-000298	DIODE-ZENER		BZX84-C5V6	5.6V/25mW	ZD02	1	1
86	DB93-10117A	2 PIN HARNESS				CN11	1	1
87	3711-000260	AC MOTOR CONNECT		YVW39E-05AV	BLU	CN71	1	1
88	2007-000033	R-CHIP		0ohm 5%, 1/4W TP 3216	JUMPER WIRE R-CHIP	J2	1	1
89	3812-001283	JUMPER WIRE			JUMPER WIRE	J3	1	1
90	3812-001283	JUMPER WIRE			JUMPER WIRE	J4	1	1
91	3812-001283	JUMPER WIRE			JUMPER WIRE	J5	1	1
92	3812-001283	JUMPER WIRE			JUMPER WIRE	J6	1	1
93	3812-001283	JUMPER WIRE			JUMPER WIRE	J7	1	1
94	3812-001283	JUMPER WIRE			JUMPER WIRE	J8	1	1
95	3812-001283	JUMPER WIRE			JUMPER WIRE	J9	1	1
96	3812-001283	JUMPER WIRE			JUMPER WIRE	J10	1	1
97	3812-001283	JUMPER WIRE			JUMPER WIRE	J11	1	1
98	2007-000033	R-CHIP		0ohm 5%, 1/4W TP 3216	JUMPER WIRE R-CHIP	J12	1	1
99	3812-001283	JUMPER WIRE			JUMPER WIRE	J13	1	1
100	3812-001283	JUMPER WIRE			JUMPER WIRE	J14	1	1
101	3812-001283	JUMPER WIRE			JUMPER WIRE	J15	1	1
102	3812-001283	JUMPER WIRE			JUMPER WIRE	J16	1	1
103	3812-001283	JUMPER WIRE			JUMPER WIRE	J17	1	1
104	2007-000033	R-CHIP		0ohm 5%, 1/4W TP 3216	JUMPER WIRE R-CHIP	J18	1	1
105	2007-000033	R-CHIP		0ohm 5%, 1/4W TP 3216	JUMPER WIRE R-CHIP	J19	1	1
106	3812-001283	JUMPER WIRE			JUMPER WIRE	J20	1	1
107	2007-000033	R-CHIP		0ohm 5%, 1/4W TP 3216	JUMPER WIRE R-CHIP	J21	1	1
108	3812-001283	JUMPER WIRE			JUMPER WIRE	J22	1	1
109	3812-001283	JUMPER WIRE			JUMPER WIRE	J23	1	1
110	2007-000033	R-CHIP		0ohm 5%, 1/4W TP 3216	JUMPER WIRE R-CHIP	J24	1	1
111	3812-001283	JUMPER WIRE			JUMPER WIRE	J25	1	1
112	2007-000033	R-CHIP		0ohm 5%, 1/4W TP 3216	JUMPER WIRE R-CHIP	J26	1	1
113	2007-000033	R-CHIP		0ohm 5%, 1/4W TP 3216	JUMPER WIRE R-CHIP	J27	1	1
114	2007-000033	R-CHIP		0ohm 5%, 1/4W TP 3216	JUMPER WIRE R-CHIP	J28	1	1
115	3812-001283	JUMPER WIRE			JUMPER WIRE	J29	1	1
116	2007-000033	R-CHIP		0ohm 5%, 1/4W TP 3216	JUMPER WIRE R-CHIP	J30	1	1
117	3812-001283	JUMPER WIRE			JUMPER WIRE	J31	1	1
118	3812-001283	JUMPER WIRE			JUMPER WIRE	J32	1	1
119	3812-001283	JUMPER WIRE						

6-2. Electrical Part List

Table with columns: NO, CODE, DESC_SPECS, PARA1, PARA2, LOCATION, BLOCK, DB93-10860A, DB93-10860B. It lists various electronic components like resistors, capacitors, diodes, ICs, and connectors with their specifications and part numbers.

6-2. Electrical Part List

■ Assy Control In

No	CODE	DESC_SPEC	PARA1	PARA2	AQ18TSASER	AS18TSEAXCH
1	*	ASSY CASE CONTROL IN			DB93-10854C DB90-06305A	DB93-10854D DB90-06305B
2		CASE CONTROL IN			DB61-04577A	DB61-04577A
2	DB61-01097A	HOLDER WIRE CLAMP			1	1
2	6001-000929	SCREW			1	1
2	6002-000231	SCREW			2	2
2	DB93-10916A	WI RE- POWER(N, OUTFAN, 4WAY)	AWG #20 150mm H/P		0	0
2	DB93-10916D	WI RE- POWER(N)	AWG #20 150mm C/O		0	0
2	DB93-10916B	WI RE- POWER(N, OUTFAN, 4WAY)	AWG #18 150mm 18K. A POWER H/P		1	0
2	DB93-10916E	WI RE- POWER(N)	AWG #18 150mm 18K. A POWER C/O		0	1
2	DB93-08572A		BRN, AWG #18		0	0
2	DB93-05803B		BRN, AWG #14 18K. A POWER		1	1
2	DB65-00176D	TERMINAL BLOCK	[N(1), 1, 2, 3]		1	0
2	DB65-00061F	TERMINAL BLOCK	[N(1), 1]		0	1
2	DB68-02809A	LABEL BAR CODE			1	1

LEVEL	CODE	DESC_SPEC	PARA1	PARA2	AQ24TSASER/AQ18TSBNSER/AQ18TSAN/AQ18TSBNSER/AQ24TSAN/AQ24TSBNSER	AS24TSEAXCH
1		ASSY CASE CONTROL IN			DB93-10855A	DB93-10855B
2	*	CASE CONTROL IN			DB90-06306A	DB90-06306B
2	DB61-01097A	HOLDER WIRE CLAMP			DB61-04576A	DB61-04576A
2	6001-000929	SCREW			1	1
2	6002-000231	SCREW			3	3
2	DB93-10916B	WIRE-POWER(N, OUTFAN, 4WAY)	AWG #18 150mm 18K. A POWER H/P		1	0
2	DB93-10916E	WIRE-POWER(N)	AWG #18 150mm 18K. A POWER C/O		0	1
2	DB65-00105Y	TERMINAL BLOCK	[N, L, N(1), 1, 2, 3]	24K H/P	1	0
2	DB65-00176G	TERMINAL BLOCK	[N, L, N(1), 1]	24K C/O	0	1
2	DB65-00176D	TERMINAL BLOCK	[N(1), 1, 2, 3]	18K H/P	0	0
2	DB65-00061F	TERMINAL BLOCK	[N(1), 1]	18K C/O	0	0
2	3501-001335	RELAY POWER	30A		1	1
2	NEW CODE	RELAY POWER	30A		0	0
2	DB93-05803B	T/B(1) TO RY71(3)	BRN, AWG #14 18K. A POWER		0	0
2	DB93-04339J	C/W T/B(N) TO T/B (N(1))	mm AWG#14, SKY/BLU		1	1
2	DB93-04339K	C/W T/B(1) TO 30A-RELAY(4)	mm AWG#14, RED		1	1
2	DB93-04339K	C/W T/B (L) TO 30A-RELAY(1)	mm AWG#14, RED		1	1
2	DB93-04339L	C/W T/B(N) TO 30A-RELAY(6)	mm AWG#16, SKY/BLU		1	1
2	DB93-04339T	C/W T/B(L) TO 25A-RELAY(4)	mm AWG#16, BRN		1	1
2	DB93-04339N	C/W 25A-RELAY(3) TO 30A-RELAY(5)	mm AWG#16, BRN		1	1
2	DB93-04339V	C/W TO RELAY	AWG#14 BRN		0	0
2	DB93-11195A	C/W TO PBA 12V CONNECT	12V BLK		0	0
2	DB68-02809A	LABEL BAR CODE			1	1
2	DB65-10088D	CABLE TIE	100mm		1	1

6-2. Electrical Part List

■ Ass'y MAIN DISPLAY PART LIST

No	CODE	DESC_SPEC	PARA1	PARA2	LOCATION	DB93-10861A
1	DB41-01017A	FR-1,PCB,35*75	FR-1	35*75	PCB	1
2	0401-001099	DIODE-SWITCHING;1N4148WS,75V,150mA,SOD-323,TP	DIODE-SWITCHING	1N4148WS	D01	1
3	0504-000127	TR-DIGITAL;FJV3102R,NPN,200mW,10K/10Kohm,SOT-23,TP	TR-DIGITAL	NPN	Q01	1
4	0504-000127	TR-DIGITAL;FJV3102R,NPN,200mW,10K/10Kohm,SOT-23,TP	TR-DIGITAL	NPN	Q03	1
5	0504-000127	TR-DIGITAL;FJV3102R,NPN,200mW,10K/10Kohm,SOT-23,TP	TR-DIGITAL	NPN	Q02	1
6	0601-003048	ROUND,GRN,3 Pl,573mm,3.0x5.0mm	LED		LED5	1
7	0601-003048	ROUND,GRN,3 Pl,573mm,3.0x5.0mm	LED		LED7	1
8	0601-003048	ROUND,GRN,3 Pl,573mm,3.0x5.0mm	LED		LED6	1
9	0609-001391	346HF12AP (6.5mm)	MODULE REMOCON		IC01	1
10	1404-001632	THERMISTOR-NTC;10Kohm,3435K(25/85),3mW/C,3mm,BULK,	NTC	10Kohm	NTC01	0
11	2007-000072	R-CHIP;47ohm,5%,1/10W,TP,1608	R-CHIP	47ohm,1608	R03	1
12	2007-000084	R-CHIP;4.7Kohm,5%,1/10W,TP,1608	R-CHIP	4.7Kohm,1608	R01	1
13	2007-000090	R-CHIP;10Kohm,5%,1/10W,TP,1608	R-CHIP	10Kohm,1608	R02	1
14	2007-001318	R-CHIP;1Kohm,5%,1/4W,TP,3216	R-CHIP	1Kohm,3216	R04	1
15	2007-001318	R-CHIP;1Kohm,5%,1/4W,TP,3216	R-CHIP	1Kohm,3216	R06	1
16	2007-001318	R-CHIP;1Kohm,5%,1/4W,TP,3216	R-CHIP	1Kohm,3216	R09	1
17	2007-001318	R-CHIP;1Kohm,5%,1/4W,TP,3216	R-CHIP	1Kohm,3216	R08	1
18	2007-001318	R-CHIP;1Kohm,5%,1/4W,TP,3216	R-CHIP	1Kohm,3216	R07	1
19	2007-001318	R-CHIP;1Kohm,5%,1/4W,TP,3216	R-CHIP	1Kohm,3216	R05	1
20	2203-000440	C-CER,CHIP;1nF,10%,50V,X7R,TP,1608	C-CER,CHIP	1nF,1608	C03	1
21	2203-005249	C-CER,CHIP;100nF,10%,50V,X7R,TP,1608	C-CER,CHIP	100nF,1608	C02	1
22	2203-005249	C-CER,CHIP;100nF,10%,50V,X7R,TP,1608	C-CER,CHIP	100nF,1608	C01	1
23	2401-002619	C-AL;47uF,20%,25V,GP,TP,5x11.5	C-AL	47uF,25V	C04	1
24	3404-001220	SWITCH-TACT;12V,50mA,160gf,6x6x5,SPST	SWITCH	12V,50mA	SW01	1
25	3711-004742	HEADER-BOARD TO CABLE;BOX,9P,1R,2mm,ANGLE,SN,IVR	CONNECT	9P	CN01	1
26	2007-000033	R-CHIP	0ohm,5%,1/4W,TP,32JUMP		J1	1
27	2007-000033	R-CHIP	0ohm,5%,1/4W,TP,32JUMP		J2	1
28	DB93-10943B	9PIN 100mm	WRE	9P	CN01-1	1

8. Schematic Diagram

8-1. PCB Circuit Description

8-1-1. Indoor Unit

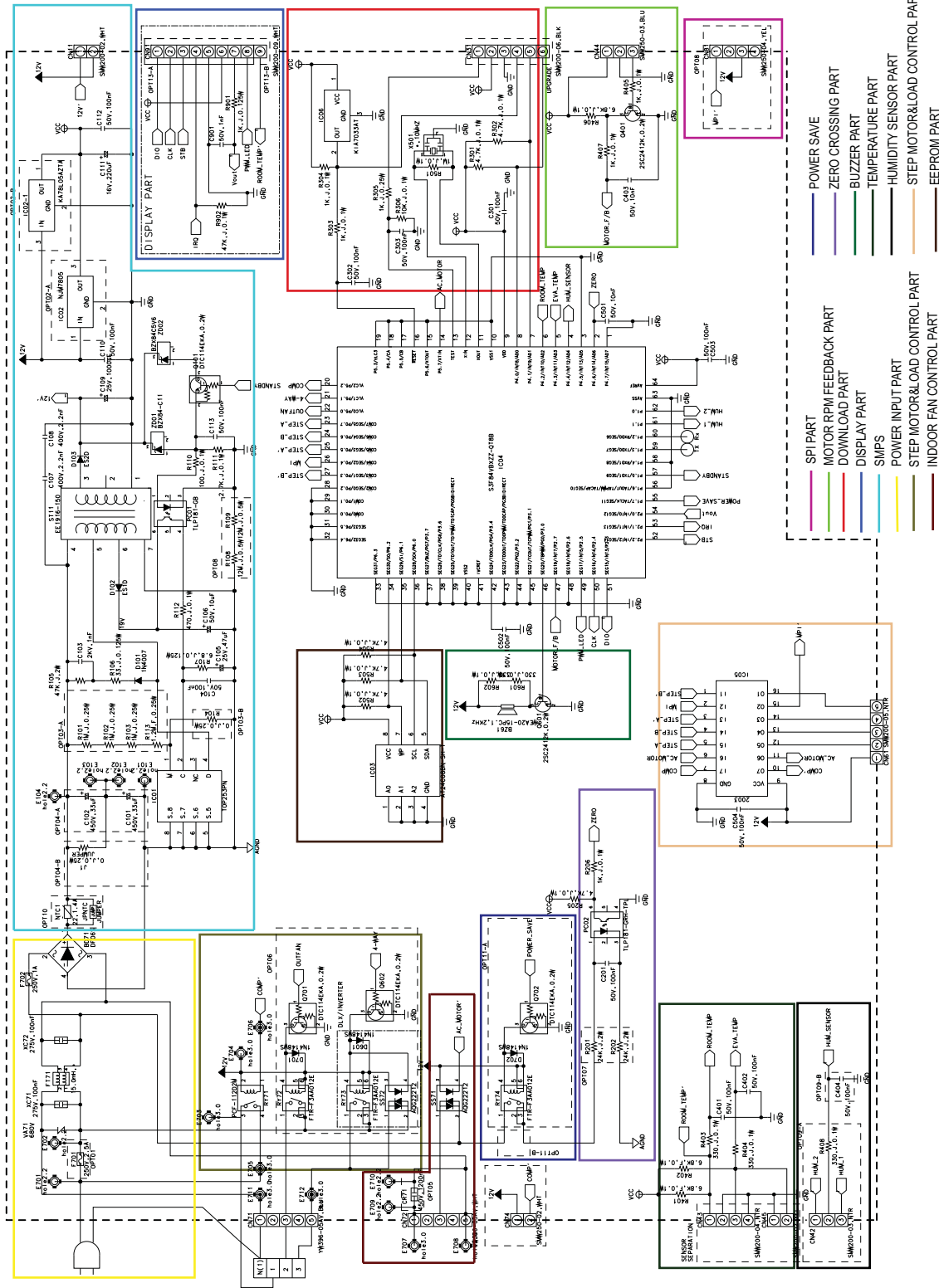



8-1-2.Display

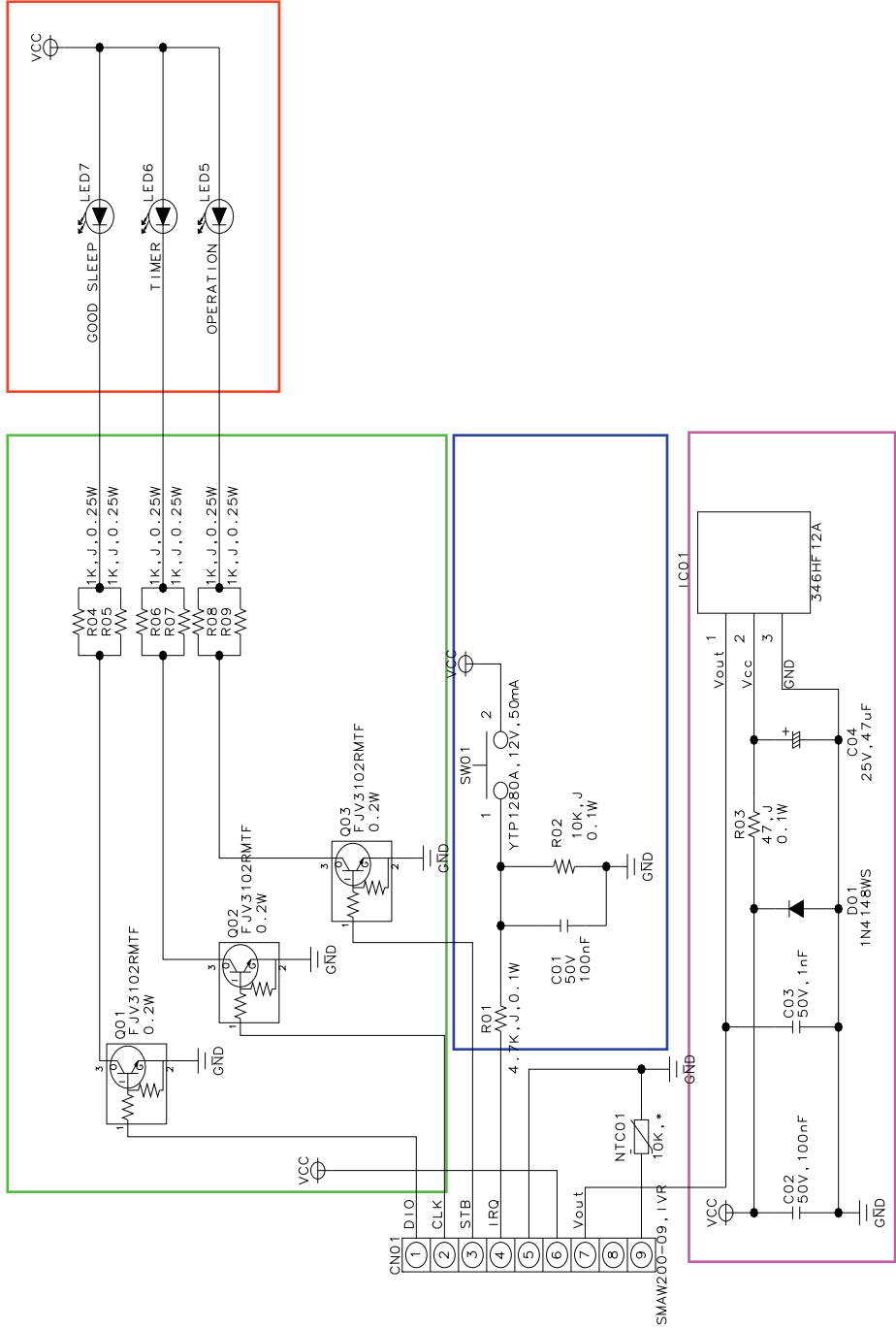

- LED LAMP PART
- DISPLAY DRIVING PART
- SWITCH PART
- REMOCON SIGNAL RECEIVING PART

9. Reference Sheet

9-1 Refrigerating Cycle Diagram

- AQ** (Heat Pump)

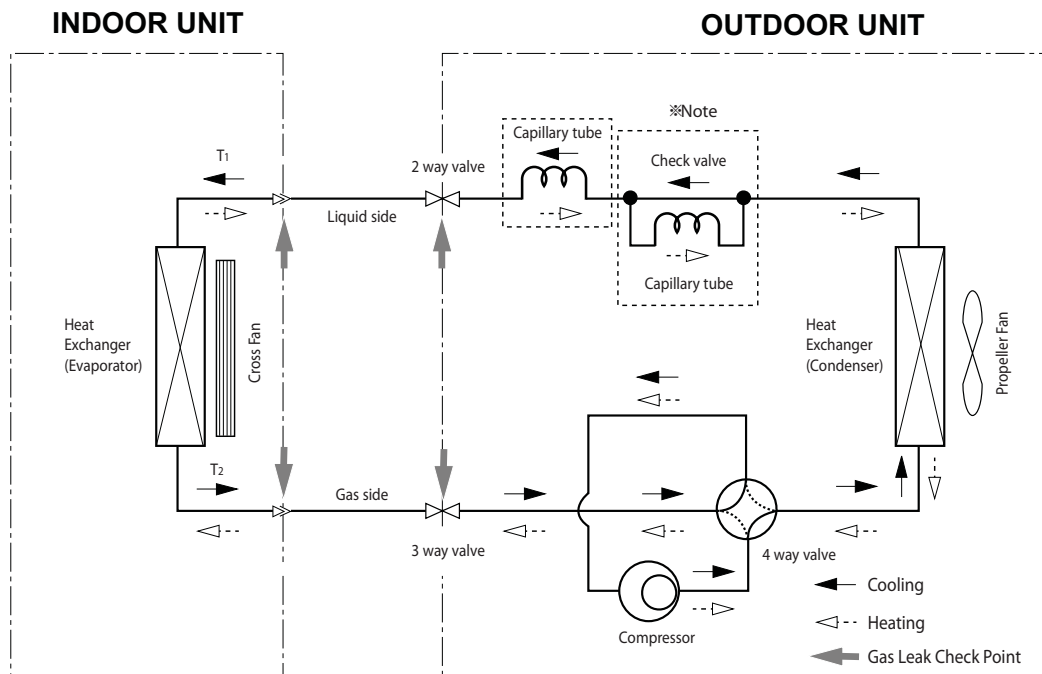

- AS** (Cooling Only)

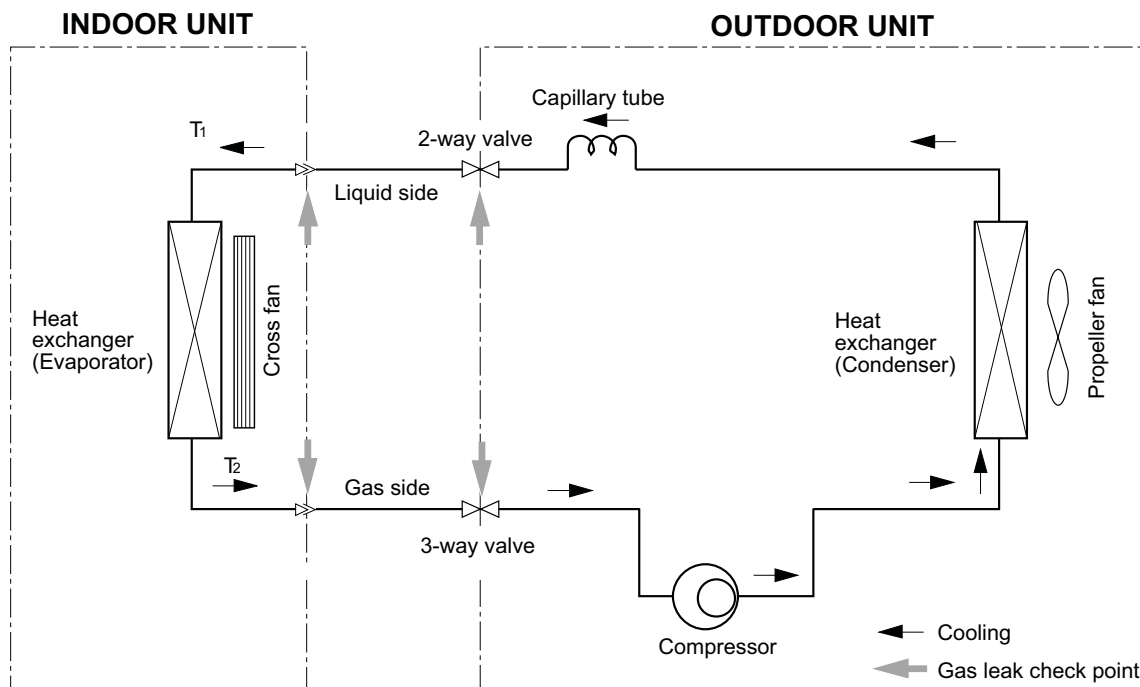



9-2 Index for Model Name

* Project model code for overseas from 2008(For RAC Export Models)

Model Code

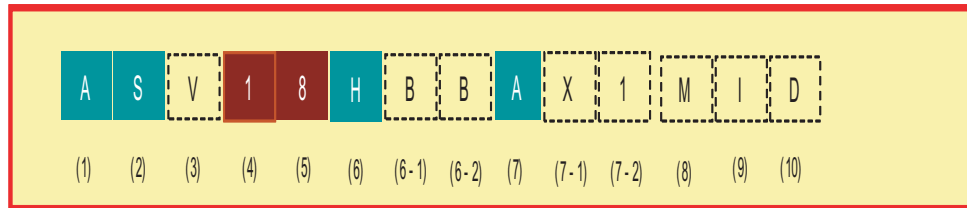

(1), (2) Cycle		(6) Project		(6-1) Color		(7) Version	
AS	Cooling Only	A	Mont Blanc(Premium)	B	Black	A-K	SSEC
AQ	Heat Pump	B	Crystal	S	Silver	L-S	TSE
		C	Max(Smart)	W	White	T-Z	SEDA
		D	Mont Blanc(Deluxe)	F	La Fleur		
(3) Inverter Capacity		E	Crystal (Vivaldi Deluxe)	U	Blue	(8), (9), (10) Buyer Code	
V	Inverter	F	Forte	G	Grey	MID	MIDDLE EAST
	Non Inverter	G	GP	(6-2) Rating Voltage		SER	RUSSIA
		H	HB	A	115V, 60Hz	XCH	CHILE
(4), (5)		J	WW Premium	B	220V, 60Hz	XAX	MEXICO
Btu (example)		K	Jungfrau -PRM	C	208-230V, 60Hz		
09	9,000 Btu	L	Forte Deluxe	D	200-220V, 50Hz		
12	12,000 Btu	M	Moderato	E	220-240V, 50Hz		
18	18,000 Btu	N	Neo Forte				
24	24,000 Btu	P	Maldives				
		R	Max Smart (Vivaldi Std)				
		S	Forte Smart(SSEC)				
		T	Boracay				
		U	Max (Vivaldi Standard)				
		V	Vivace				
		W	WW				
		X	Forte Smart(TSE)				
		Y	Jungfrau -DLX				



9-3 Pressure & Capacity mark

■Power/Heat

W	cal/s	kcal/h	Btu/h	HP	kg·m/s	lb·m/s
1	0.23885	0.85985	3.4121	0.001341	0.10197	0.73756
4.1868	1	3.6	14.286	0.0056146	0.42693	3.088
1.163	0.27778	1	3.9683	0.0015596	0.11859	0.85778
0.29307	0.06999	0.252	1	3.9302×10^{-4}	0.029885	0.21616
745.7	178.11	641.19	2,544.4	1	76.04	550
9.8067	2.3423	8.4322	33.462	0.013151	1	7.233
1.3558	0.32383	1.1658	4.6262	0.0018182	0.13826	199



9-4 Low Refrigerant Pressure Distribution

Note : • Please measure the refrigerant pressure after the air conditioner operates on testing cooling mode during more than 10 minutes.

- Indoor Temp. Variation : 21°C ~ 32°C
- Outdoor Temp. Variation : 20°C ~ 45°C

- **18**

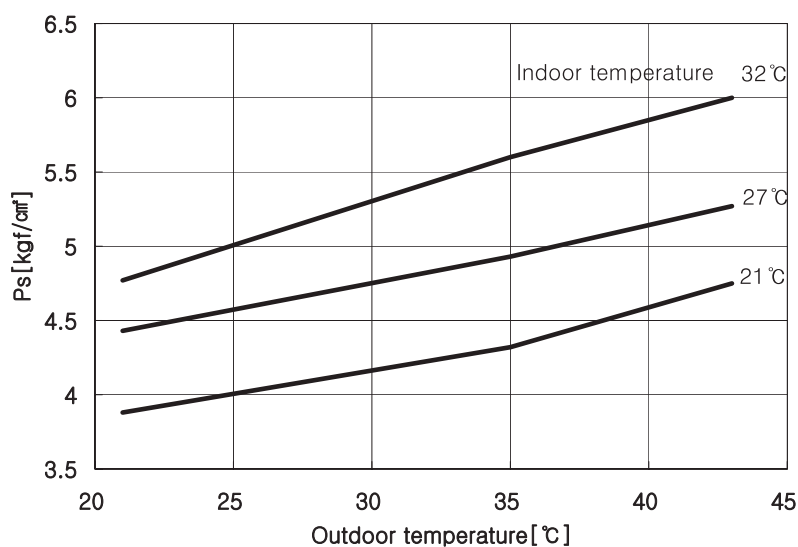

- **24**

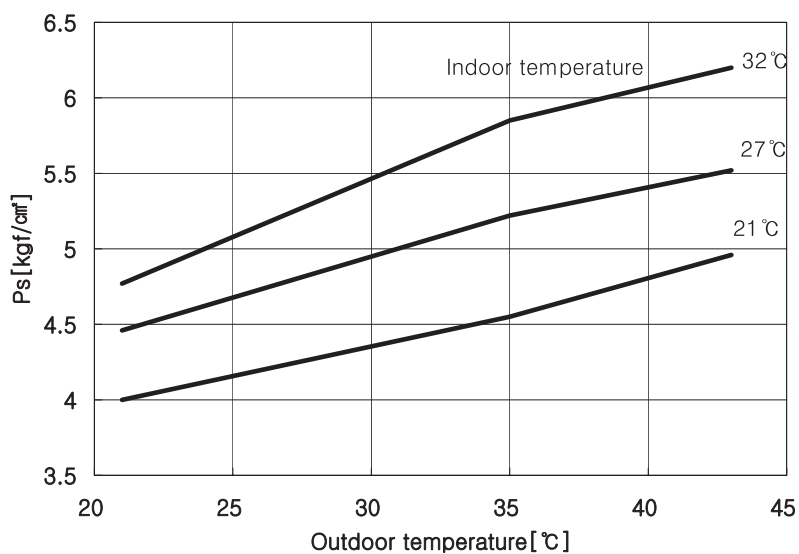

9-5 Installation Diagram of Indoor Unit and Outdoor Unit

9-5-1 Air-Purge Procedure

1) Connect each assembly pipe to the appropriate valve on the outdoor unit and tighten the flare nut.



2) Connect the charging hose of low pressure side of manifold gauge to the packed valve having a service port (3/8" Packed valve) as shown at the figure.



3) Open the valve of the low pressure side of manifold gauge counter-clockwise.



4) Purge the air from the system using vacuum pump for about 30 minutes.
- After that, please recheck that pressure is stabilized.
- Close the valve of the low pressure side of manifold gauge clockwise.
- Remove the hose of the low pressure side of manifold gauge.



5) Set valve cork of both liquid side and gas side of packed valve to the open position.



6) Mount the valve stem nuts to the 2 way and 3 way valve. And mount the service port cap to 3 way valve.



7) Check for gas leakage.
- At this time, especially check for gas leakage from the 3 way valve's stem nuts, and from the service port cap.

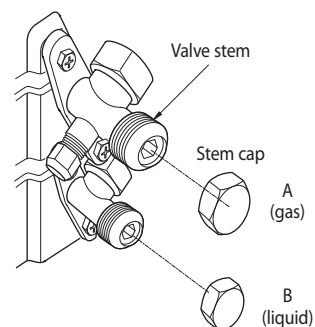
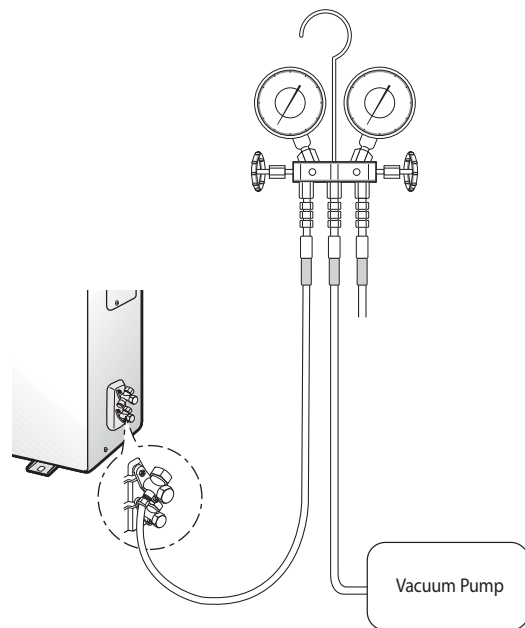
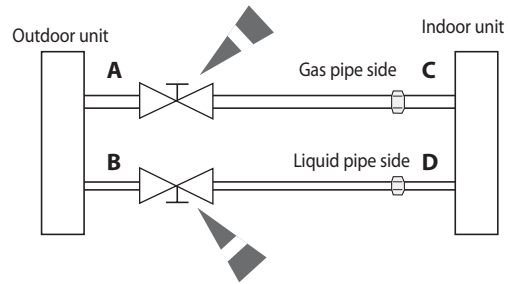

9-5-2 "Pump down" Procedure

Pump down will be carried out when an evaporator is replaced or when the unit is relocated in another area.

1) Remove the caps from the 3 way valve and the 3 way valve.



2) Turn the 3 way valve clockwise to close and connect a pressure gauge (low pressure side) to the service valve, and open the 3 way valve again.



3) Set the unit to cool operation mode.
(Check if the compressor is operating.)



4) Turn the 3 way valve clockwise to close.



5) When the pressure gauge indicates "0" turn the 3 way valve clockwise to close.



6) Stop operation of the air conditioner.



7) Close the cap of each valve.

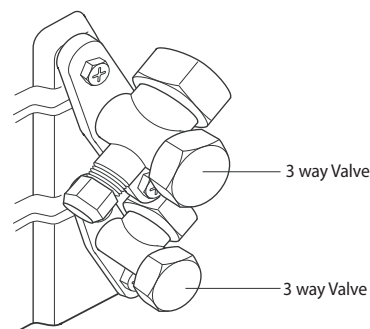

Remarks

Relocation of the air conditioner

- Refer to this procedure when the unit is relocated.
- Carry out the pump down procedure (refer to the details of 'pump down').
- Remove the power cord.
- Disconnect the assembly cable from the indoor and outdoor units.
- Remove the flare nut connecting the indoor unit and the pipe.
- At this time, cover the pipe of the indoor unit and the other pipe using a cap or vinyl plug to avoid foreign material entering.
- Disconnect the pipe connected to the outdoor unit.
At this time, cover the valve of the outdoor unit and the other pipe using a cap or vinyl plug to avoid foreign material entering.
- Make sure you do not bend the connection pipes in the middle and store together with the cables.
- Move the indoor and outdoor units to a new location.
- Remove the mounting plate for the indoor unit and move it to a new location.



GSPN(Global Service Partner Network)

Area	Web Site
North America	http://service.samsungportal.com
Latin America	http://latin.samsungportal.com
CIS	http://cis.samsungportal.com
Europe	http://europe.samsungportal.com
China	http://china.samsungportal.com
Asia	http://asia.samsungportal.com
Mideast & Africa	http://mea.samsungportal.com

This Service Manual is a property of Samsung Electronics Co., Ltd.
Any unauthorized use of Manual can be punished under applicable
International and/or domestic law.

© Samsung Electronics Co., Ltd. Sep. 2008.
Code No. DB98-30365A(1)



Большая библиотека технической документации
<http://splitoff.ru/tehn-doc.html>
каталоги, инструкции, сервисные мануалы, схемы.